

FABAS LUCE



Edition 1.1

www.fabasluce.it



Edition 1.1

a modular vision of light

Kit Luci è il sistema modulare firmato Fabas Luce che consente di progettare l'illuminazione in modo flessibile e personalizzato. Una collezione ampia di diffusori e montature combinabili, studiata per rispondere a diverse esigenze estetiche e funzionali che permette di ottenere un prodotto esclusivo grazie a oltre 5.000 possibili diverse combinazioni!

Disponibile con sorgenti LED e Edison, in versione a sospensione o da tavolo, il sistema permette di intervenire sui singoli componenti, facilitando aggiornamenti e personalizzazioni nel tempo senza intervenire sull'intero apparecchio. Un approccio progettuale che valorizza la qualità della luce, l'estetica e la durata del prodotto.



Kit Luci is Fabas Luce's modular system that allows you to design lighting in a flexible and customised way. A wide collection of diffusers and frames that can be combined to meet different aesthetic and functional requirements, allowing you to create an exclusive product thanks to over 5,000 possible combinations!

Available with LED and Edison light sources, in pendant or table versions, the system allows you to work on individual components, facilitating updates and customisations over time without having to intervene on the entire fixture. A design approach that enhances the quality of light, aesthetics and durability of the product.

shape your light

Kit Luci è disponibile in versione LED e Edison, offrendo due soluzioni luminose differenti ma complementari.

Kit Luci is available in LED or Edison versions, offering two distinct yet complementary lighting solutions.

try our configurator

Lighting Solutions



Edison E14



Edison E27



Led 8W



Led 14W



<https://configuratore.fabasluce.it>

a modular light

EDISON

Il sistema Edison prevede rosoni e diffusori in vetro completi di cavo, personalizzabili attraverso la scelta di cavi, bloccacavi e distanziali coordinati. Una soluzione che unisce libertà compositiva, attenzione al dettaglio estetico e possibilità di aggiornamento nel tempo.

The Edison system features ceiling canopies and glass diffusers supplied with cable, customizable through the choice of coordinated cables, cable grips, and glass holders. A solution that combines compositional freedom, attention to aesthetic detail, and long-term upgradability.

Crea la tua sospensione con la lampadina EDISON
Create your suspension with edison bulb

Scegli la montatura e accessori

Choose the frame and accessories
page 54 - 61

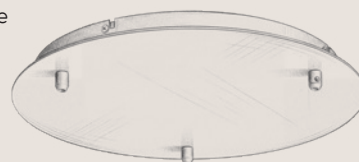

Scegli il vetro
Choose the glass
page 10 - 53



LED

Nel sistema LED, la sorgente luminosa è integrata nella montatura di design e protetta da un disco in metacrilato. I diffusori in vetro o metallo si avvitano facilmente alla montatura, permettendo composizioni rapide e aggiornabili nel tempo. È possibile selezionare la temperatura colore della luce (2700K, 3000K o 4000K), per una personalizzazione semplice e immediata dell'illuminazione.

In the LED system, the light source is integrated into a designed, design-led fitting and protected by a methacrylate disc. Glass or metal diffusers are easily screwed onto the fitting, allowing quick configurations that can be updated over time. The light color temperature can be selected (2700K, 3000K, or 4000K), enabling simple and immediate lighting customization.

Sorgente luminosa con cambio temperatura colore.
Light source with colour temperature change.



Crea la tua sospensione a LED
Create your LED suspension

Scegli la montatura
Choose the frame
page 160 - 173

Scegli il paralume
Choose the lampshade
page 68 - 159

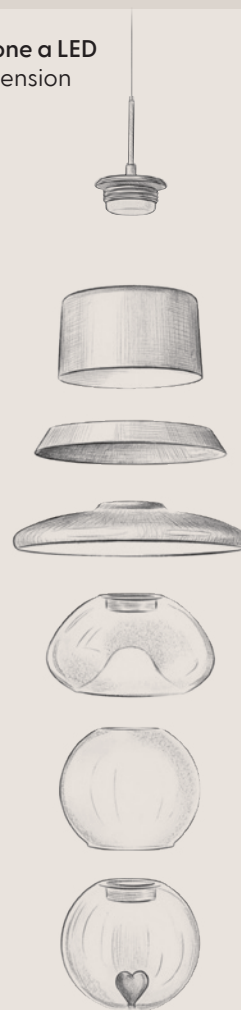

kit LUCI EDISON



page 08

kit LUCI
LEO



page 66

EDISON

edolo, lila, ela,
maia, silo, infinity,
vivienne

Ogni diffusore nasce come un gesto progettuale autonomo, in cui il vetro diventa linguaggio e la luce materia espressiva. Forme, volumi e superfici definiscono personalità diverse, pensate per essere scelte, combinate e interpretate. Questa panoramica presenta l'intera collezione di diffusori Kit Luci, con i relativi nomi e riferimenti di pagina, come un atlante di possibilità progettuali.

Each diffuser is conceived as an independent design gesture, where glass becomes language and light an expressive material. Shapes, volumes, and surfaces define distinct personalities, designed to be selected, combined, and interpreted. This overview presents the complete Kit Luci diffuser collection, with corresponding names and page references, as an atlas of design possibilities.



EDOLO 10



LILA 20



ELA 30



MAIA 34



SILO 38



INFINITY 42



VIVIENNE 48



FRAMES 54 - 61

e dolo



Il design essenziale di questo diffusore in vetro si distingue per una struttura a doppio involucro: un vetro esterno colorato, dalla forma morbida e ribassata, racchiude un elemento interno più stretto in vetro satinato. Questa combinazione crea un raffinato gioco di trasparenze e profondità, modulando la luce in modo delicato e avvolgente. La finitura a specchio dona un accento contemporaneo e ricercato, rendendo il diffusore un elemento elegante e versatile, capace di arricchire l'ambiente con discrezione e armonia.



The essential design of this glass diffuser is distinguished by a double-shell structure: a softly contoured, low-slung, colored outer glass encloses a slimmer inner element in satin-finished glass. This combination creates a refined interplay of transparency and depth, gently modulating the light with a soft, enveloping effect. The mirrored finish adds a contemporary, sophisticated accent, making the diffuser an elegant and versatile element capable of enhancing any space with discretion and harmony.









Diffusore in vetro, in sei finiture colore e tre dimensioni - E14 e E27-, compatibile con le montature singole o multiple in tre colori. Il cavo trasparente o nero, di lunghezza massima 3500 mm, unitamente al portalampade è incluso con il vetro.

Glass diffuser available in six color finishes and three sizes—for E14 and E27—compatible with single or multiple frames in three color options. The transparent or black cable, with a maximum length of 3500 mm, together with the lampholder, is included with the glass.





E14 40W



3787-59-382

-  **107** Ametista - Amethyst

-  **125** Ambra - Amber

-  **126** Fumè - Transparent grey

-  **189** Oro - Gold

-  **241** Trasparente - Transparent

-  **382** Marrone chiaro - Light brown



Ø 160
H 245

Cavo trasparente lunghezza 3500 mm. Su richiesta è possibile fornire il cavo nella lunghezza desiderata.
Transparent cable length 3500 mm. On request, the cable can be supplied in the desired length.

CE   IP20

FRAME Options page 54 - 61

Round Frames



1 Lights Round



3 Lights Round



3 Lights Round



5 Lights Round



9 Lights Round



2 Lights Radial



4 Lights Radial

Rectangular Frames



3 Lights Rectangular



5 Lights Rectangular



5 Lights Rectangular



6 Lights Oval

Black Kit Cable



Kit cable

Accessories



Support for
cable fixing



Cable keeper

E27 40W



3787-50-382



3787-01-382

-  **107** Ametista - Amethyst

-  **125** Ambra - Amber

-  **126** Fumè - Transparent grey

-  **189** Oro - Gold

-  **241** Trasparente - Transparent

-  **382** Marrone chiaro - Light brown

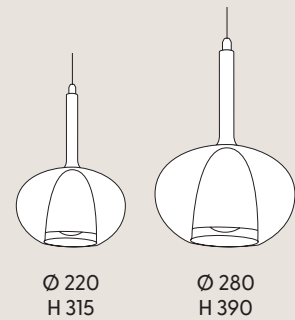

Cavo trasparente lunghezza 3500 mm. Su richiesta è possibile fornire il cavo nella lunghezza desiderata.
Transparent cable length 3500 mm. On request, the cable can be supplied in the desired length.

CE   IP20

FRAME Options page 54 - 61

Round Frames



1 Light Round



3 Lights Round



3 Lights Round



5 Lights Round



9 Lights Round



2 Lights Radial



4 Lights Radial

Rectangular Frames



3 Lights Rectangular



5 Lights Rectangular



5 Lights Rectangular



6 Lights Oval

Black Kit Cable



Kit cable

Accessories



Support for cable fixing



Cable keeper

lila



Diffusore in vetro dal design essenziale, prende forma in una linea a goccia elegante e affusolata, che esalta la verticalità della sospensione. La struttura a doppio vetro combina un involucro esterno colorato con un elemento interno più stretto in vetro satinato, creando un raffinato dialogo tra trasparenze e volumi. La luce, filtrata dal vetro interno, risulta morbida e diffusa, mentre la superficie esterna genera riflessi delicati che arricchiscono l'ambiente con leggerezza. La finitura conferisce un carattere contemporaneo e sofisticato, rendendo il diffusore ideale sia come elemento singolo sia in composizioni multiple, per ambienti moderni o più classici.



A glass diffuser with a minimalist design, it features an elegant and tapered teardrop shape, enhancing the verticality of the suspension. The double-glass structure combines a colored outer shape with a slimmer inner element in satin-finished glass, creating a refined dialogue between transparency and volume. The light, filtered through the inner glass, is soft and diffused, while the outer surface generates delicate reflections that enrich the space with lightness. The finish adds a contemporary, sophisticated character, making the diffuser ideal both as a single suspension and in multiple compositions, for modern as well as more classic interiors.









Diffusore in vetro, in sei finiture colore e tre dimensioni - E14 e E27-, compatibile con le montature singole o multiple in tre colori. Il cavo trasparente o nero, di lunghezza massima 3500 mm, unitamente al portalampade è incluso con il vetro.

Glass diffuser available in six color finishes and three sizes—for E14 and E27—compatible with single or multiple frames in three color options. The transparent or black cable, with a maximum length of 3500 mm, together with the lampholder, is included with the glass.







E14 40W





3481-59-107

-  **107** Ametista - Amethyst

-  **125** Ambra - Amber

-  **126** Fumè - Transparent grey

-  **140** Verde trasparente - Transparent green

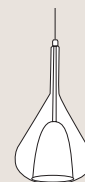

-  **241** Trasparente - Transparent

-  **244** Azzurro trasparente - Light blue



Ø 150
H 265

Cavo trasparente lunghezza 3500 mm. Su richiesta è possibile fornire il cavo nella lunghezza desiderata.
 Transparent cable length 3500 mm. On request, the cable can be supplied in the desired length.

CE   IP20

FRAME Options page 54 - 61

Round Frames



1 Light Round



3 Lights Round



3 Lights Round



5 Lights Round



9 Lights Round



2 Lights Radial



4 Lights Radial

Rectangular Frames



3 Lights Rectangular



5 Lights Rectangular



5 Lights Rectangular



6 Lights Oval

Black Kit Cable



Kit cable

Accessories



Support for
cable fixing



Cable keeper

E27 40W





3481-50-107





3481-01-107

-  **107** Ametista - Amethyst

-  **125** Ambra - Amber

-  **126** Fumè - Transparent grey

-  **140** Verde trasparente - Transparent green

-  **241** Trasparente - Transparent

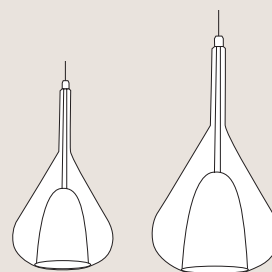

-  **244** Azzurro trasparente - Light blue



Ø 220
H 350

Ø 250
H 430

Cavo trasparente lunghezza 3500 mm. Su richiesta è possibile fornire il cavo nella lunghezza desiderata.
Transparent cable length 3500 mm. On request, the cable can be supplied in the desired length.

CE   IP20

FRAME Options page 54 - 61

Round Frames



1 Light Round



3 Lights Round



3 Lights Round



5 Lights Round



9 Lights Round



2 Lights Radial



4 Lights Radial

Rectangular Frames



3 Lights Rectangular



5 Lights Rectangular



5 Lights Rectangular



6 Lights Oval

Black Kit Cable



Kit cable

Accessories



Support for
cable fixing



Cable keeper

ela



Il design essenziale di questo diffusore in vetro si esprime attraverso una forma ellittica schiacciata, compatta e armoniosa, che conferisce leggerezza e equilibrio alla sospensione. La superficie continua valorizza la purezza del materiale, mentre la finitura a specchio genera riflessi morbidi e luminosi. La luce viene diffusa in modo uniforme, creando un'atmosfera accogliente e raffinata. Un elemento versatile e contemporaneo, ideale sia come pezzo singolo sia in composizioni multiple, capace di integrarsi con naturalezza in contesti moderni e più classici.



The essential design of this glass diffuser is expressed through a flattened elliptical shape, compact and harmonious, that brings lightness and balance to the suspension. The continuous surface enhances the purity of the material, while the mirrored finish generates soft, luminous reflections. The light is evenly diffused, creating a warm and refined atmosphere. A versatile, contemporary element, ideal both as a single feature and in multiple compositions, capable of integrating effortlessly into both modern and more classic settings.



Diffusore in vetro, in due finiture colore e unica dimensioni - E27-, compatibile con le montature singole o multiple in tre colori. Il cavo nero, di lunghezza massima 3500 mm, unitamente al portalampade è incluso con il vetro.

Glass diffuser available in two color finishes and one size—for E27—compatible with single or multiple frames in three color options. The black cable, with a maximum length of 3500 mm, together with the lampholder, is included with the glass.

E27 60W



3489-50-125

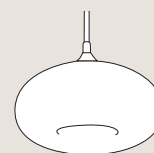

 **125** Ambra - Amber

 **126** Fumè - Transparent grey



Ø 270
H 140

Cavo nero lunghezza 3500 mm. Su richiesta è possibile fornire il cavo nella lunghezza desiderata.
Black cable length 3500 mm. On request, the cable can be supplied in the desired length.

CE   IP20

FRAME Options page 54 - 61

Round Frames



1 Light Round



3 Lights Round



3 Lights Round



5 Lights Round



9 Lights Round



2 Lights Radial



4 Lights Radial



Rectangular Frames



3 Lights Rectangular



5 Lights Rectangular



5 Lights Rectangular



6 Lights Oval

Accessories



Support for
cable fixing



Cable keeper

maia





Il design essenziale di questo diffusore in vetro si distingue per una forma a cupola morbida e avvolgente, caratterizzata da un rientro sulla base che ne alleggerisce il profilo e ne definisce il volume. La luce viene diffusa in modo uniforme, dando vita a un'atmosfera accogliente e raffinata. Un elemento elegante e versatile, ideale sia come sospensione singola sia in composizioni multiple, pensato per integrarsi con naturalezza in contesti moderni e più classici.

The essential design of this glass diffuser is distinguished by a soft, enveloping dome shape, characterized by a recessed base that lightens the profile and shapes the volume. The light is diffused evenly, creating a warm and refined atmosphere. An elegant and versatile element, ideal both as a single suspension and in multiple compositions, designed to integrate naturally into modern as well as more classic settings.



Diffusore in vetro, in due finiture colore e due dimensioni - E27-, compatibile con le montature singole o multiple in tre colori. Il cavo nero, di lunghezza massima 3500 mm, unitamente al portalampane è incluso con il vetro.

Glass diffuser available in two color finishes and two sizes—for E27-compatible with single or multiple frames in three color options. The black cable, with a maximum length of 3500 mm, together with the lampholder, is included with the glass.

E27 40W





3490-59-125

E27 60W



3490-50-125

 **125** Ambra - Amber

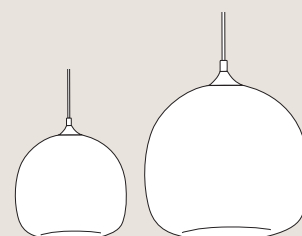

 **126** Fumè - Transparent grey



Ø 230
H 210

Ø 310
H 280

Cavo nero lunghezza 3500 mm. Su richiesta è possibile fornire il cavo nella lunghezza desiderata.
 Black cable length 3500 mm. On request, the cable can be supplied in the desired length.

CE   IP20

FRAME Options page 54 - 61

Round Frames



1 Light Round



3 Lights Round



3 Lights Round



5 Lights Round



9 Lights Round



2 Lights Radial



4 Lights Radial

Rectangular Frames



3 Lights Rectangular



5 Lights Rectangular



5 Lights Rectangular



6 Lights Oval

Accessories



Support for
cable fixing



Cable keeper

Silo



Diffusore in vetro a forma cilindrica pulita e proporzionata, definita da un rientro sulla base che ne alleggerisce il volume e ne accentua l'eleganza. La superficie continua valorizza la purezza del materiale, mentre la finitura genera riflessi morbidi e luminosi, capaci di arricchire l'ambiente con discrezione. La luce viene diffusa in modo uniforme, creando un'atmosfera raffinata e accogliente. Un elemento versatile e contemporaneo, ideale sia come sospensione singola sia in composizioni multiple, capace di integrarsi con naturalezza in contesti moderni e più classici.

Glass diffuser with a clean and well-proportioned cylindrical shape, defined by a recessed base that lightens its volume and accentuates its elegance. The continuous surface enhances the purity of the material, while the finish generates soft, luminous reflections that subtly enrich the space. The light is diffused evenly, creating a refined and welcoming atmosphere. A versatile, contemporary element, ideal both as a single suspension and in multiple compositions, capable of integrating effortlessly into both modern and more classic settings.





Diffusore in vetro, in due finiture colore e due dimensioni - E27-, compatibile con le montature singole o multiple in tre colori. Il cavo nero, di lunghezza massima 3500 mm, unitamente al portalampade è incluso con il vetro.

Glass diffuser available in two color finishes and two sizes—for E27-compatible with single or multiple frames in three color options. The black cable, with a maximum length of 3500 mm, together with the lampholder, is included with the glass.

E27 40W





3491-59-125

E27 60W



3491-50-125

 **125** Ambra - Amber

 **126** Fumè - Transparent grey





Ø 135
H 230



Ø 180
H 310

Cavo nero lunghezza 3500 mm. Su richiesta è possibile fornire il cavo nella lunghezza desiderata.
 Black cable length 3500 mm. On request, the cable can be supplied in the desired length.

CE   IP20

FRAME Options page 54 - 61

Round Frames



1 Light Round



3 Lights Round



3 Lights Round



5 Lights Round



9 Lights Round



2 Lights Radial



4 Lights Radial



Rectangular Frames



3 Lights Rectangular



5 Lights Rectangular



5 Lights Rectangular



6 Lights Oval

Accessories



Support for
cable fixing



Cable keeper

Infinity



Il design essenziale di questo diffusore in vetro si sviluppa in una forma ellittica verticale, slanciata ed equilibrata, caratterizzata da un foro alla base che ne definisce la struttura e ne alleggerisce la percezione visiva. La superficie, lievemente sfaccettata, rompe la continuità del vetro liscio creando un raffinato gioco di riflessi e vibrazioni luminose. Un elemento contemporaneo e ricercato, ideale sia come sospensione singola sia in composizioni multiple, capace di arricchire l'ambiente con discrezione e carattere.



The essential design of this glass diffuser takes shape in a slender, well-balanced vertical elliptical form, characterized by a hole at the base that defines its structure and lightens its visual perception. The slightly faceted surface breaks the continuity of the smooth glass, creating a refined interplay of reflections and luminous vibrations. A contemporary, sophisticated element, ideal both as a single suspension and in multiple compositions, capable of enriching any space with discretion and character.



Diffusore in vetro, in due finiture colore e due dimensioni - E27-, compatibile con le montature singole o multiple in tre colori. Il cavo nero, di lunghezza massima 3500 mm, unitamente al portalampade è incluso con il vetro.

Glass diffuser available in two color finishes and two sizes—for E27—compatible with single or multiple frames in three color options. The black cable, with a maximum length of 3500 mm, together with the lampholder, is included with the glass.





Technical information

Infinity

E27 60W



3519-59-365



3519-50-365



126 Fumè - Transparent grey



365 Cognac



Ø 200
H 280



Ø 250
H 360

Cavo nero lunghezza 3500 mm. Su richiesta è possibile fornire il cavo nella lunghezza desiderata.
Black cable length 3500 mm. On request, the cable can be supplied in the desired length.

CE IP20

FRAME Options page 54 - 61

Round Frames



1 Light Round



3 Lights Round



3 Lights Round



5 Lights Round



9 Lights Round



2 Lights Radial



4 Lights Radial



Rectangular Frames



3 Lights Rectangular



5 Lights Rectangular



5 Lights Rectangular



6 Lights Oval

Accessories



Support for
cable fixix



Cable keeper

VIVIENNE



Vetro sferico interamente bianco e opaco, dalla presenza morbida e luminosa, caratterizzato da un taglio alla base che ne interrompe la perfetta rotondità. Questo dettaglio da cui fuoriesce la luce è integrato con discrezione nel taglio inferiore, diventando parte del disegno e contribuendo a una diffusione morbida e uniforme.





Spherical glass, entirely white and matt, with a soft and luminous appearance, defined by a cut at the base that interrupts its perfect roundness. This detail, from which the light emerges, is discreetly integrated into the lower cut, becoming a part of the design and contributing to a soft and uniform diffusion.



Diffusore in vetro, in unica finitura colore e tre dimensioni - E27-, compatibile con le montature singole o multiple in tre colori. Il cavo trasparente, di lunghezza massima 3500 mm, unitamente al portalampade è incluso con il vetro.

Glass diffuser available in a single color finish and three sizes—for E27—compatible with single or multiple frames in three color options. The transparent cable, with a maximum length of 3500 mm, together with the lampholder, is included with the glass.



Technical information

VIVIENNE

E27 40W



3780-52-102



3780-51-102



3780-50-102

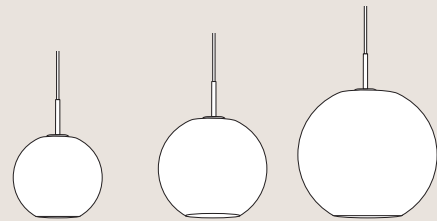

Ø 200
H 180

Ø 250
H 225

Ø 300
H 280

102 Bianco - White

Cavo trasparente lunghezza 3500 mm. Su richiesta è possibile fornire il cavo nella lunghezza desiderata.
Transparent cable length 3500 mm. On request, the cable can be supplied in the desired length.

CE IP20

FRAME Options page 54 - 61

Round Frames



1 Light Round



3 Lights Round



3 Lights Round



5 Lights Round



9 Lights Round



2 Lights Radial



4 Lights Radial

Rectangular Frames



3 Lights Rectangular



5 Lights Rectangular



5 Lights Rectangular



6 Lights Oval

Accessories



Support for cable fixing



Cable keeper

Technical information

round frames

EDISON

Montatura in metallo / Metal structure



▲ Tonda 1 luce
Round 1 light

Cavo non incluso
Cable not included

● **3481-57-101**
Nero - Black
Bloccacavo cromo - Chrome cable keeper

● **3481-57-102**
Bianco - White
Bloccacavo cromo - Chrome cable keeper

● **3481-57-189**
Oro - Gold
Bloccacavo oro - Gold cable keeper

Diffusori in vetro - Glass diffuser
Options page 10 - 53

Technical information

round frames

EDISON

Montatura in metallo / Metal structure

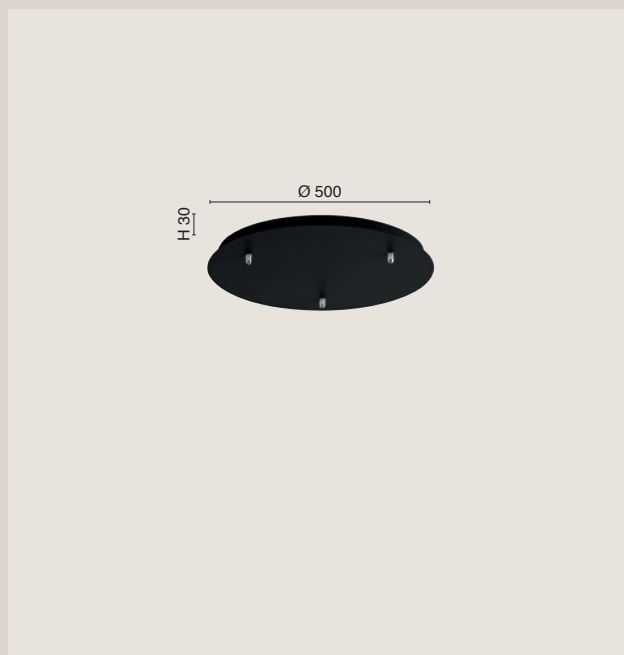
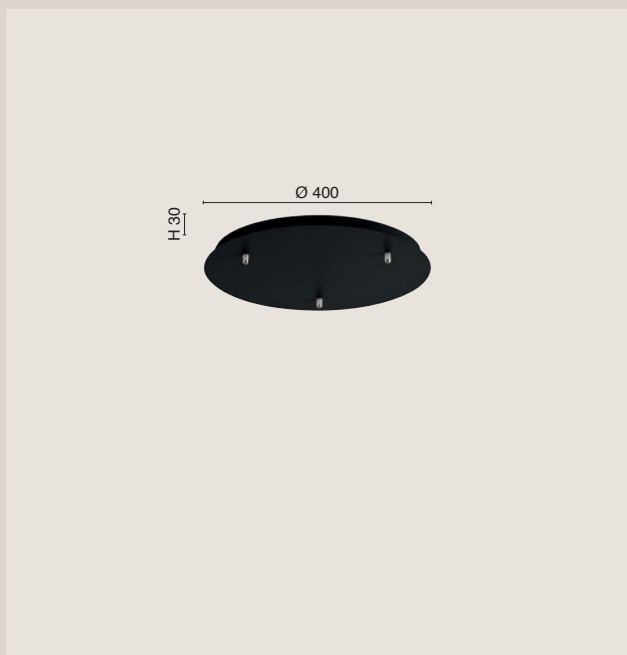

▲ Tonda 3 luci
Round 3 lights

Cavo non incluso
Cable not included



3481-58-101
Nero - Black
Bloccacavo cromo - Chrome cable keeper



3481-58-102
Bianco - White
Bloccacavo cromo - Chrome cable keeper



3481-58-189
Oro - Gold
Bloccacavo oro - Gold cable keeper

▲ Tonda 3 luci
Round 3 lights

Cavo non incluso
Cable not included



3481-51-101
Nero - Black
Bloccacavo cromo - Chrome cable keeper



3481-51-102
Bianco - White
Bloccacavo cromo - Chrome cable keeper



3481-51-189
Oro - Gold
Bloccacavo oro - Gold cable keeper

Diffusori in vetro - Glass diffuser
Options page 10 - 53

Technical information

round frames

EDISON

Montatura in metallo / Metal structure

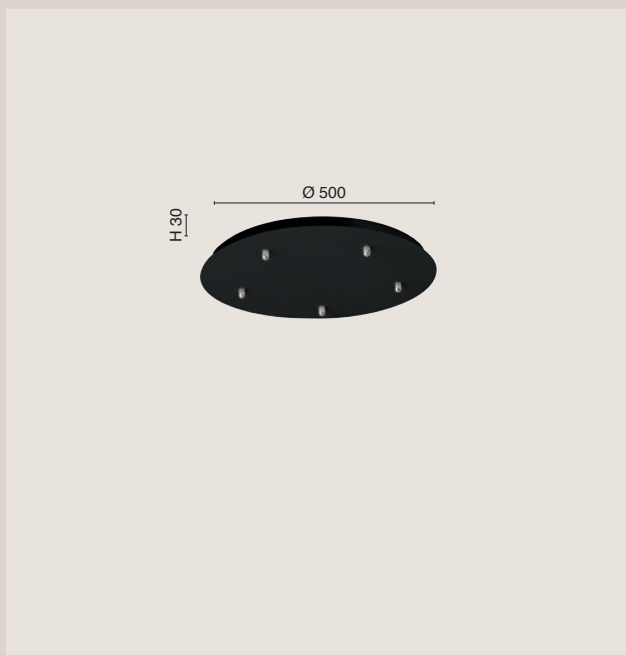

▲ Tonda 5 luci
Round 5 lights

Cavo non incluso
Cable not included



3481-52-101
Nero - Black
Bloccacavo cromo - Chrome cable keeper



3481-52-102
Bianco - White
Bloccacavo cromo - Chrome cable keeper



3481-52-189
Oro - Gold
Bloccacavo oro - Gold cable keeper



▲ Tonda 9 luci
Round 9 lights

Cavo non incluso
Cable not included



3749-55-101
Nero - Black
Bloccacavo nero - Black cable keeper



3749-55-102
Bianco - White
Bloccacavo bianco - White cable keeper



3749-55-189
Oro - Gold
Bloccacavo oro - Gold cable keeper

Diffusori in vetro - Glass diffuser
Options page 10 - 53

Technical information

round frames

EDISON

Montatura in metallo / Metal structure

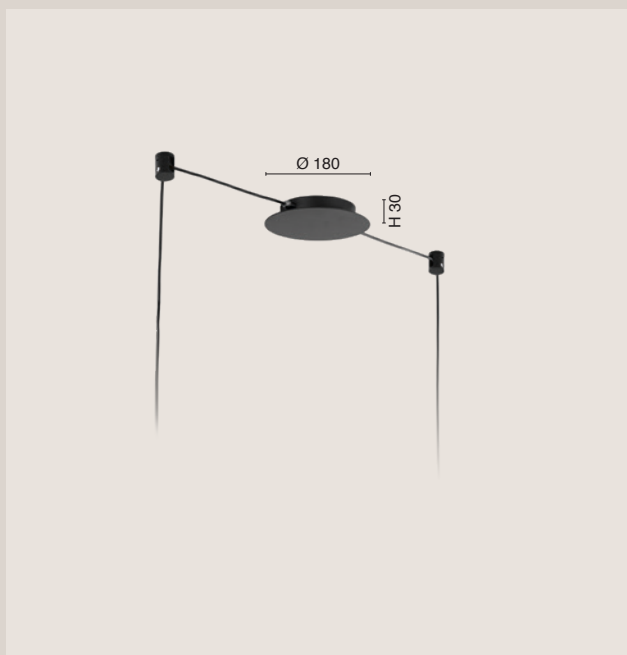

▲ Tondo radiale 2 luci
Radial round 2 lights

2 supporti per cavo inclusi * - Cavo non incluso
2 cable supports included * - Cable not included



3749-52-101
Nero - Black
*Accessorio Nero - Black accessory



3749-52-102
Bianco - White
*Accessorio Cromo - Chrome accessory



3749-52-189
Oro - Gold
*Accessorio Oro - Gold accessory



▲ Tondo radiale 4 luci
Radial round 4 lights

4 supporti per cavo inclusi * - Cavo non incluso
4 cable supports included * - Cable not included



3749-54-101
Nero - Black
*Accessorio Nero - Black accessory



3749-54-102
Bianco - White
*Accessorio Cromo - Chrome accessory



3749-54-189
Oro - Gold
*Accessorio Oro - Gold accessory

Diffusori in vetro - Glass diffuser

Options page 10 - 53

Technical information

rectangular frames

EDISON

Montatura in metallo / Metal structure



▲ Rettangolare 3 luci
Rectangular 3 lights

Cavo non incluso
Cable not included



3481-53-101
Nero - Black
Bloccacavo cromo - Chrome cable keeper



3481-53-102
Bianco - White
Bloccacavo cromo - Chrome cable keeper



3481-53-189
Oro - Gold
Bloccacavo oro - Gold cable keeper



▲ Rettangolare 5 luci
Rectangular 5 lights

Cavo non incluso
Cable not included



3481-55-101
Nero - Black
Bloccacavo cromo - Chrome cable keeper



3481-55-102
Bianco - White
Bloccacavo cromo - Chrome cable keeper



3481-55-189
Oro - Gold
Bloccacavo oro - Gold cable keeper

Diffusori in vetro - Glass diffuser
Options page 10 - 53

Technical information

rectangular frames

EDISON

Montatura in metallo / Metal structure

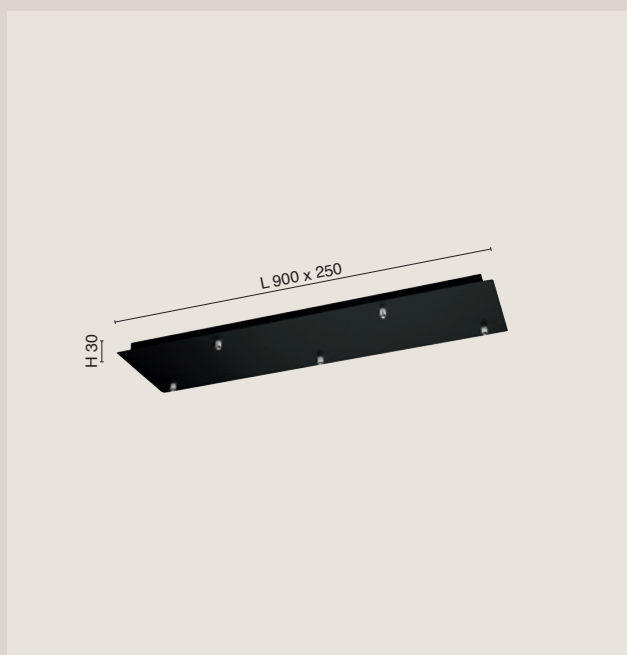

- ▲ Rettangolare 5 luci
Rectangular 5 lights

Cavo non incluso
Cable not included

● **3481-54-101**
Nero - Black
Bloccacavo cromo - Chrome cable keeper

● **3481-54-102**
Bianco - White
Bloccacavo cromo - Chrome cable keeper

● **3481-54-189**
Oro - Gold
Bloccacavo oro - Gold cable keeper

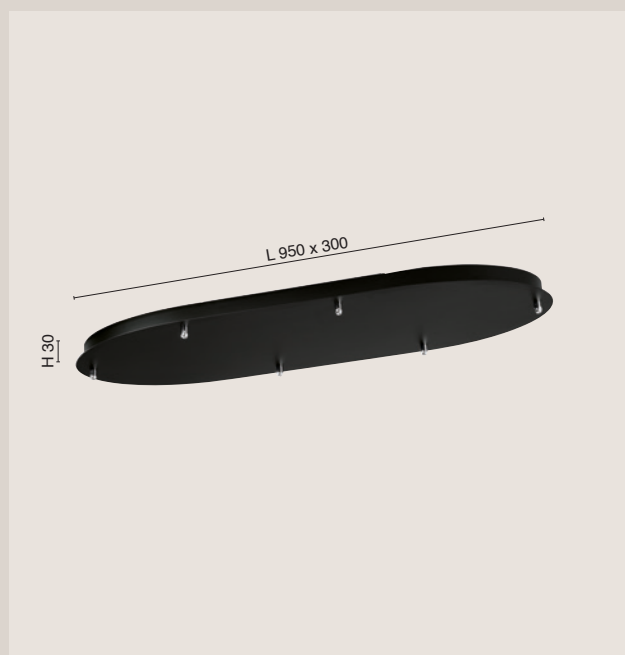

- ▲ Ovale 6 luci
Oval 6 lights

Cavo non incluso
Cable not included

● **3481-56-101**
Nero - Black
Bloccacavo cromo - Chrome cable keeper

● **3481-56-102**
Bianco - White
Bloccacavo cromo - Chrome cable keeper

● **3481-56-189**
Oro - Gold
Bloccacavo oro - Gold cable keeper

Diffusori in vetro - Glass diffuser

Options page 10 - 53

Technical information
accessories

EDISON

Montatura in metallo / Metal structure

Supporto aggiuntivo per fissaggio cavo
Additional cable fastening bracket

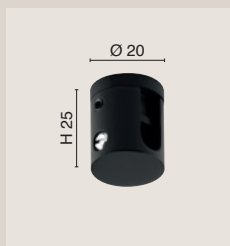

3749-59-101
Nero - Black

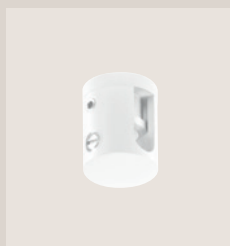

3749-59-102
Bianco - White



3749-59-189
Oro - Gold



3749-59-119
Ottone satinato
Satined brass



3749-59-138
Cromo - Chrome

Supporto aggiuntivo bloccacavo
Additional support cable keeper



MBC1013481
Nero - Black

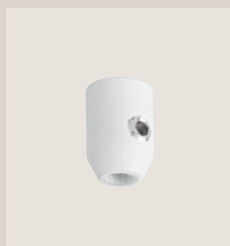

MBC1023481
Bianco - White

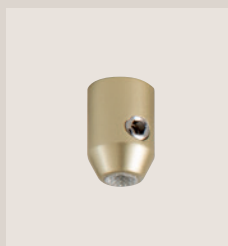

MBC1893481
Oro - Gold



MBC1193481
Ottone satinato
Satined brass



MBC1383481
Cromo - Chrome

Lavorazioni su richiesta
Customization on demand

1500-01-028 Allungamento cavo / Extra cable length

1500-01-029 Sostituzione cavo con kit nero / Cable replacement with black kit cable

Technical information

accessories

EDISON

Montatura in metallo / Metal structure

Kit cavo nero ideale per personalizzare l'estetica del corpo illuminante
Black kit cable, ideal for customizing the aesthetic of the light fixture

Ogni kit è fornito di un bloccacavo nero aggiuntivo per il rosone.
Each kit includes an additional black cable keeper for the frame.

Each kit includes an additional black cable keeper for the frame.



Compatibile vetri LILA
Compatible with LILA glass



3481-04-101
Nero - Black
E14 MODEL: **3481-59**

Compatibile vetri LILA
Compatible with LILA glass



3481-03-101
Nero - Black
E27 MODEL: **3481-50**

Compatibile vetri LILA
Compatible with LILA glass



3481-02-101
Nero - Black
E27 MODEL: **3481-01**

Compatibile vetri EDOLO
Compatible with EDOLO glass



3787-04-101
Nero - Black
E14 MODEL: **3787-59**

Compatibile vetri EDOLO
Compatible with EDOLO glass



3787-03-101
Nero - Black
E27 MODEL: **3787-50**

Compatibile vetri EDOLO
Compatible with EDOLO glass



3787-02-101
Nero - Black
E27 MODEL: **3787-01**



Cavo per / Cable for:
MAIA/SILO/ELA/FIONA



ECV1013496
Nero - Black



Cavo per / Cable for:
EDOLO/LILA



ECV1013757
Nero - Black



Cavo per / Cable for:
EDOLO/LILA



ECV0003780
Trasparente - Transparent

Diffusori in vetro - Glass diffuser
Options page 10 - 53

Overview glass diffuser

H 245
Ø 160
page 18

3787-59-107	3787-59-125	3787-59-126	3787-59-189	3787-59-241	3787-59-241	3787-59-382
Ametista Amethyst	Ambra Amber	Fumé Transparent grey	Oro Gold	Trasparente Transparent	Trasparente Transparent	Marrone chiaro Light brown

H 315
Ø 220
page 19

3787-50-107	3787-50-125	3787-50-126	3787-50-189	3787-50-241	3787-50-241	3787-50-382
Ametista Amethyst	Ambra Amber	Fumé Transparent grey	Oro Gold	Trasparente Transparent	Trasparente Transparent	Marrone chiaro Light brown

H 390
Ø 280
page 19

3787-01-107	3787-01-125	3787-01-126	3787-01-189	3787-01-241	3787-01-241	3787-01-382
Ametista Amethyst	Ambra Amber	Fumé Transparent grey	Oro Gold	Trasparente Transparent	Trasparente Transparent	Marrone chiaro Light brown

H 265
Ø 150
page 28

3481-59-107	3481-59-125	3481-59-126	3481-59-140	3481-59-241	3481-59-241	3481-59-244
Ametista Amethyst	Ambra Amber	Fumé Transparent grey	Verde chiaro Light green	Trasparente Transparent	Trasparente Transparent	Azzurro Light blue

H 350
Ø 220
page 29

3481-50-107	3481-50-125	3481-50-126	3481-50-140	3481-50-241	3481-50-241	3481-50-244
Ametista Amethyst	Ambra Amber	Fumé Transparent grey	Verde chiaro Light green	Trasparente Transparent	Trasparente Transparent	Azzurro Light blue

H 430
Ø 250
page 29

3481-01-107	3481-01-125	3481-01-126	3481-01-140	3481-01-241	3481-01-241	3481-01-244
Ametista Amethyst	Ambra Amber	Fumé Transparent grey	Verde chiaro Light green	Trasparente Transparent	Trasparente Transparent	Azzurro Light blue

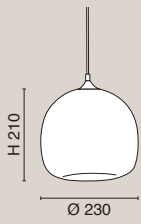

page 37



3490-59-125
■ Ambra
Amber



3490-59-126
■ Fumé
Transparent grey

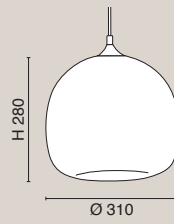

page 37



3490-50-125
■ Ambra
Amber



3490-50-126
■ Fumé
Transparent grey

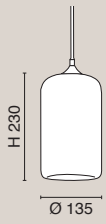

page 41



3491-59-125
■ Ambra
Amber



3491-59-126
■ Fumé
Transparent grey

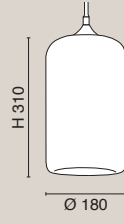

page 41



3491-50-125
■ Ambra
Amber



3491-50-126
■ Fumé
Transparent grey

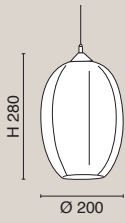

page 47



3519-59-365
■ Cognac



3519-59-126
■ Fumé
Transparent grey

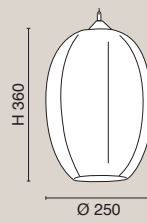

page 47



3519-50-365
■ Cognac



3519-50-126
■ Fumé
Transparent grey

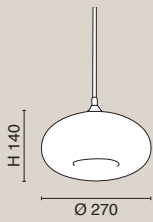

page 33



3489-50-125
■ Ambra
Amber



3489-50-126
■ Fumé
Transparent grey

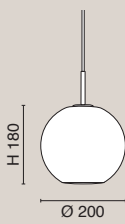

page 53



3780-52-102
□ Bianco
White

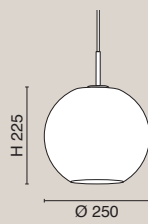

page 53



3780-51-102
□ Bianco
White

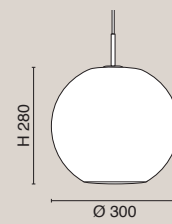

page 53



3780-50-102
□ Bianco
White

Overview frames

Ø 130



Single Recessed

3481-57-101 page 54
■ Nero - Black

□ Bianco - White

3481-57-189
■ Oro - Gold

Ø 400



3 Lights Round

3481-58-101 page 55
■ Nero - Black

□ Bianco - White

3481-58-189
■ Oro - Gold

Ø 500



3 Lights Round

3481-51-101 page 55
■ Nero - Black

□ Bianco - White

3481-51-189
■ Oro - Gold

Ø 500



5 Lights Round

3481-52-101 page 56
■ Nero - Black

□ Bianco - White

3481-52-189
■ Oro - Gold

Ø 650



9 Lights Round

3749-55-101 page 56
■ Nero - Black

□ Bianco - White

3749-55-189
■ Oro - Gold

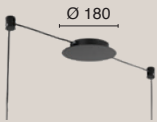

Radial 2 Lights

3749-52-101 page 57
■ Nero - Black

□ Bianco - White

3749-52-189
■ Oro - Gold

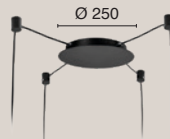

Radial 4 Lights

3749-54-101 page 57
■ Nero - Black

□ Bianco - White

3749-54-189
■ Oro - Gold



3 Lights Rectangular

3481-53-101 page 58
■ Nero - Black

□ Bianco - White

3481-53-189
■ Oro - Gold



5 Lights Rectangular

3481-55-101 page 58
■ Nero - Black

□ Bianco - White

3481-55-189
■ Oro - Gold



5 Lights Rectangular

3481-54-101 page 59

■ Nero - Black

3481-54-102

□ Bianco - White

3481-54-189

■ Oro - Gold

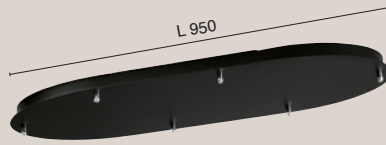

6 Lights Oval

3481-56-101 page 59

■ Nero - Black

3481-56-102

□ Bianco - White

3481-56-189

■ Oro - Gold

accessories

Ø 20



Cable supports

3749-59-101 page 60

■ Nero - Black

3749-59-102

□ Bianco - White

3749-59-119

■ Ottone satinato - Satined brass

3749-59-138

■ Cromo - Chrome

3749-59-189

■ Oro - Gold

Ø 14



Cable keeper

MBC1013481 page 60

■ Nero - Black

MBC1023481

□ Bianco - White

MBC1193481

■ Ottone satinato - Satined brass

MBC1383481

■ Cromo - Chrome

MBC1893481

■ Oro - Gold



Compatible with LILA glass
E14 model: **3481-59**

3481-04-101 page 61

■ Nero - Black

Compatible with EDOLO glass
E14 model: **3787-59**

3787-04-101 page 61

■ Nero - Black



Compatible with LILA glass
E27 model: **3481-50**

3481-03-101 page 61

■ Nero - Black

Compatible with EDOLO glass
E27 model: **3787-50**

3787-03-101 page 61

■ Nero - Black



Compatible with LILA glass
E27 model: **3481-01**

3481-02-101 page 61

■ Nero - Black

Compatible with EDOLO glass
E27 model: **3787-01**

3787-02-101 page 61

■ Nero - Black

LED

saki, nebula,
tambora, vesuvio,
fuego, libra, ariel,
dervio, devero, frua,
lucille, brena, crodo,
tully, wengen,
colico, solda, varone

I diffusori a base LED, in vetro e in metallo, nascono come espressioni autonome di design, in cui la materia diventa protagonista.

Volumi, proporzioni e superfici definiscono identità precise, pensate per dialogare con lo spazio e guidare la composizione luminosa.

Ogni diffusore è concepito come un elemento progettuale indipendente, da scegliere e combinare liberamente, capace di interpretare stili diversi e di mantenere nel tempo un linguaggio essenziale e riconoscibile.

LED-based diffusers, in glass and metal, are conceived as autonomous design expressions, where material takes center stage. Volumes, proportions, and surfaces define clear identities, designed to interact with space and guide the lighting composition.

Each diffuser is designed as an independent project element, to be freely selected and combined, capable of interpreting different styles while maintaining a clean, recognizable language over time.



SAKI 68



NEBULA 74



TAMBORA 80



VESUVIO 86



FUEGO 92



LIBRA 98

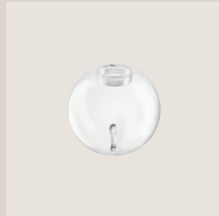

ARIEL 104

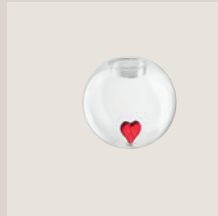

ARIEL 104

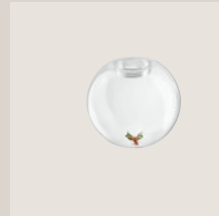

ARIEL 104



DERVIO 112



DEVERO 118



FRUA 122

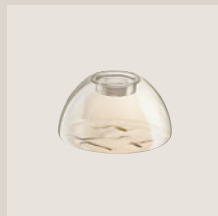

LUCILLE 126



BRENA 130



CRODO 136



TULLY 140



WENGEN 144



COLICO 148



SOLDA 152



VARONE 156



LED 8W 160 - 167



LED 14W 168 - 173

Saki



Il design essenziale di questo diffusore in vetro si distingue per una forma circolare piena e compatta, dal carattere deciso e armonioso. La superficie è arricchita da sfaccettature irregolari che animano il vetro con un raffinato gioco di riflessi e profondità, mantenendo un'estetica elegante e controllata. Un diffusore dal forte impatto visivo ma equilibrato, ideale per ambienti contemporanei e per composizioni che cercano un accento materico sofisticato.



The essential design of this glass diffuser is distinguished by a full and compact circular shape, with a bold and harmonious character. The surface is enriched with irregular facets that animate the glass with a refined interplay of reflections and depth, maintaining an elegant and controlled aesthetic. A diffuser with a strong and balanced visual impact, ideal for contemporary spaces and compositions seeking a sophisticated material accent.







Diffusore in vetro in tre dimensioni: due per l'8W e uno per il 14W, in 5 varianti colore compatibili con molteplici montature a sospensione, singole o multiple, e da tavolo.

Glass diffuser in three sizes: two for the 8W and one for the 14W, in 5 color variants compatible with multiple suspension frames—single or multiple—as well as for table modular system.

LED 8W



3848-51-125

LED 8W



3848-52-125

LED 14W



3848-53-125

- 125** Ambra - Amber

- 189** Oro - Gold

- 241** Trasparente - Transparent

- 379** Grigio chiaro sfumato - Shaded light grey

- 382** Marrone chiaro - Light brown



LED 8W Frame Options page 160 - 167

Standard Suspensions

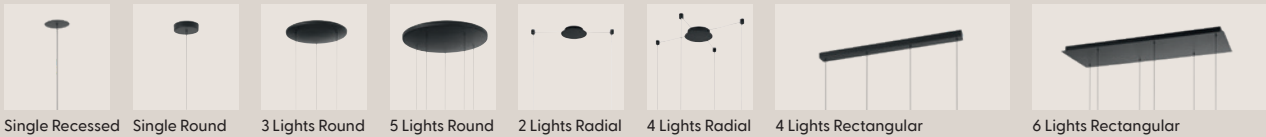

Single Recessed Single Round 3 Lights Round 5 Lights Round 2 Lights Radial 4 Lights Radial 4 Lights Rectangular 6 Lights Rectangular

Raise & Fall Suspensions



Single Round 3 Lights Round 4 Lights Rectangular 5 Lights Rectangular

Modular Suspension



Track 48V

Table Bases



Base Round Base Round

LED 14W Frame Options page 168 - 173

Standard Suspensions



Single Round 3 Lights Round 3 Lights Rectangular

Raise & Fall Suspensions



Single Round 3 Lights Round



3 Lights Rectangular

Modular Suspension



Track 48V

Table Base



Base Round

nebulula



Vetro dalla forma morbida e irregolare, simile a una nuvola, che conferisce all'oggetto un carattere leggero e spontaneo. Le linee fluide e arrotondate creano un volume delicato e dinamico, capace di dialogare con la luce in modo naturale e raffinato. Un diffusore dal linguaggio giocoso ma attuale, pensato per ambienti contemporanei e per composizioni che desiderano esprimere personalità con discrezione.



Glass with a soft, irregular shape, resembling a cloud, gives the object a light and spontaneous character. The fluid, rounded lines create a delicate and dynamic volume, capable of interacting with light in a natural and refined way. A diffuser with a playful and contemporary style, designed for modern interiors and for compositions that seek to express personality with subtle elegance.







Diffusore in vetro in due dimensioni: uno per l'8W e uno per il 14W, in 4 varianti colore compatibili con molteplici montature a sospensione, singole o multiple.

Glass diffuser available in two sizes: one for the 8W and one for the 14W, offered in 4 color variants, compatible with multiple suspension frames, single or multiple.

LED 8W

LED 14W



3849-51-125



3849-52-125

- 125** Ambra - Amber

- 241** Trasparente - Transparent

- 382** Marrone chiaro - Light brown

- 388** Bronzo sfumato - Shaded bronze

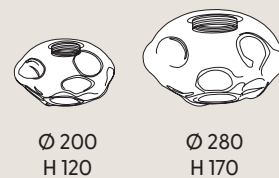

LED 8W Frame Options page 160 - 167

Standard Suspensions



Modular Suspension



Track 48V

Table Bases



Base Round

Base Round

LED 14W Frame Options page 168 - 173

Standard Suspensions



Single Round

3 Lights Round

3 Lights Rectangular

Raise & Fall Suspensions



Single Round

3 Lights Round

3 Lights Rectangular

Modular Suspension



Track 48V

Table Base



Base Round

tambora



Vetri dalla forma morbida, caratterizzati da una finitura specchiata che, a luce spenta, riflette l'ambiente con eleganza e profondità. Quando la luce è accesa, la superficie si trasforma, diventando semitrasparente e lasciando filtrare la luce in modo diffuso. Questo doppio effetto valorizza il volume del vetro e crea un raffinato gioco di riflessi e luminosità, capace di mutare l'atmosfera. Un equilibrio ricercato tra presenza decorativa e funzione illuminotecnica.

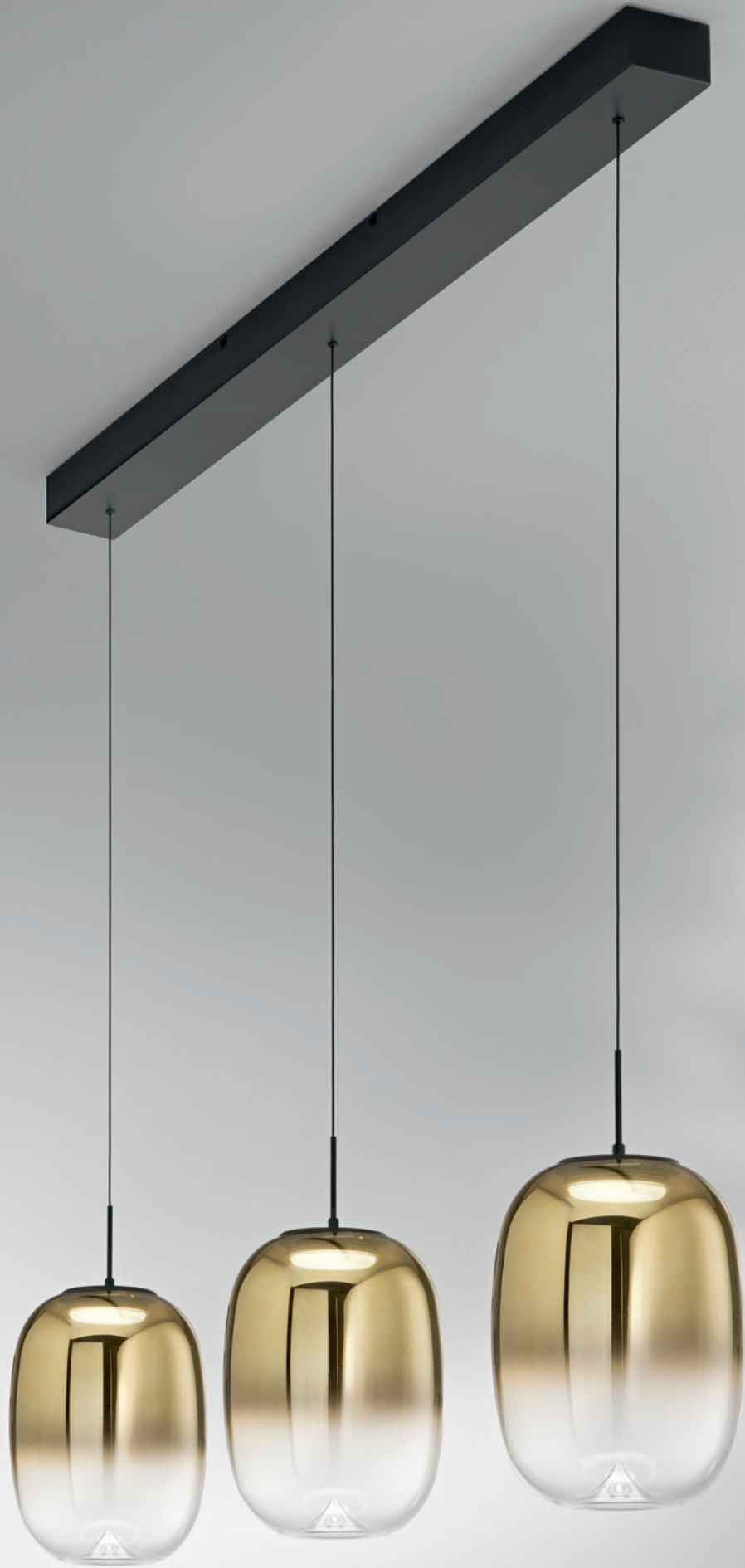



Softly shaped glass elements defined by a mirrored finish that, when the light is off, reflects the surrounding space with elegance and depth. When illuminated, the surface transforms, becoming semi-transparent and allowing diffused light to filter through. This dual effect enhances the volume of the glass and creates a refined interplay of reflections and brightness, capable of transforming the atmosphere. A refined balance between decorative presence and lighting performance.

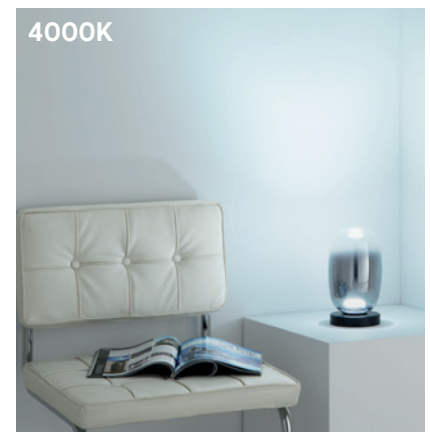



Diffusore in vetro in tre varianti colore e due misure: una più piccola compatibile con l'8W e una più grande compatibile con il 14W. Possono essere utilizzati sia a sospensione, singole o multiple, sia da tavolo.



Glass diffuser available in three color variants and two sizes: a smaller version compatible with 8W and a larger version compatible with 14W, suitable for suspension frame—single or multiple— as well as for table modular system.



Technical information

tambora

LED 8W



3824-54-378

LED 14W



3824-55-378



332 Oro sfumato - Shaded gold



378 Cognac sfumato - Shaded cognac



379 Grigio chiaro sfumato - Shaded light grey



Ø 130
H 200



Ø 200
H 280

LED 8W Frame Options page 160 - 167

Standard Suspensions



Single Recessed



Single Round



3 Lights Round



5 Lights Round



2 Lights Radial



4 Lights Radial



4 Lights Rectangular



6 Lights Rectangular

Raise & Fall Suspensions



Single Round



3 Lights Round



4 Lights Rectangular



5 Lights Rectangular

Modular Suspension



Track 48V

Table Bases



Base Round



Base Round

LED 14W Frame Options page 168 - 173

Standard Suspensions



Single Round



3 Lights Round



3 Lights Rectangular

Raise & Fall Suspensions



Single Round



3 Lights Round



3 Lights Rectangular

Modular Suspension



Track 48V

Table Base



Base Round

VESUVIO



Vetri dalla forma morbida, caratterizzati da una finitura specchiata che, a luce spenta, riflette l'ambiente con eleganza e profondità. Quando la luce è accesa, la superficie si trasforma, diventando semitrasparente e lasciando filtrare la luce in modo diffuso. Questo doppio effetto valorizza il volume del vetro e crea un raffinato gioco di riflessi e luminosità, capace di mutare l'atmosfera. Un equilibrio ricercato tra presenza decorativa e funzione illuminotecnica.







Softly shaped glass elements defined by a mirrored finish that, when the light is off, reflects the surrounding space with elegance and depth. When illuminated, the surface transforms, becoming semi-transparent and allowing diffused light to filter through. This dual effect enhances the volume of the glass and creates a refined interplay of reflections and brightness, capable of transforming the atmosphere through a refined balance between decorative presence and lighting performance.

Diffusore in vetro in tre varianti colore e due misure: una più piccola compatibile con l'8W e una più grande compatibile con il 14W. Possono essere utilizzati sia a sospensione, singole o multiple, sia da tavolo.

Glass diffuser available in three color variants and two sizes: a smaller version compatible with 8W and a larger version compatible with 14W, suitable for suspension frame—single or multiple— as well as for table modular system.



Technical information

VESUVIO

LED 8W

LED 14W



3824-52-378



3824-53-378



332 Oro sfumato - Shaded gold



378 Cognac sfumato - Shaded cognac



379 Grigio chiaro sfumato - Shaded light grey



Ø 150
H 150

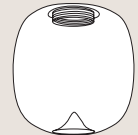

Ø 240
H 240

LED 8W Frame Options page 160 - 167

Standard Suspensions



Single Recessed



Single Round



3 Lights Round



5 Lights Round



2 Lights Radial



4 Lights Radial



4 Lights Rectangular



6 Lights Rectangular

Raise & Fall Suspensions



Single Round



3 Lights Round



4 Lights Rectangular



5 Lights Rectangular

Modular Suspension



Track 48V

Table Bases



Base Round



Base Round

LED 14W Frame Options page 168 - 173

Standard Suspensions



Single Round



3 Lights Round



3 Lights Rectangular

Raise & Fall Suspension



Single Round



3 Lights Round



3 Lights Rectangular

Modular Suspension



Track 48V

Table Base



Base Round

FUEGO



Vetri dalla forma morbida, caratterizzati da una finitura specchiata che, a luce spenta, riflette l'ambiente con eleganza e profondità. Quando la luce è accesa, la superficie si trasforma, diventando semitrasparente e lasciando filtrare la luce in modo diffuso. Questo doppio effetto valorizza il volume del vetro e crea un raffinato gioco di riflessi e luminosità, capace di mutare l'atmosfera. Un equilibrio ricercato tra presenza decorativa e funzione illuminotecnica.





Softly shaped glass elements defined by a mirrored finish that, when the light is off, reflects the surrounding space with elegance and depth. When illuminated, the surface transforms, becoming semi-transparent and allowing diffused light to filter through. This dual effect enhances the volume of the glass and creates a refined interplay of reflections and brightness, capable of transforming the atmosphere through a refined balance between decorative presence and lighting performance.





Diffusore in vetro in tre varianti colore e due misure: una più piccola compatibile con l'8W e una più grande compatibile con il 14W. Possono essere utilizzati sia a sospensione, singole o multiple, sia da tavolo.

Glass diffuser available in three color variants and two sizes: a smaller version compatible with 8W and a larger version compatible with 14W, suitable for suspension frame—single or multiple— as well as for table modular system.



Technical information

fuego

LED 8W

LED 14W



3824-50-378



3824-51-378



332 Oro sfumato - Shaded gold



378 Cognac sfumato - Shaded cognac



379 Grigio chiaro sfumato - Shaded light grey



Ø 180
H 110

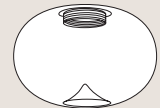

Ø 280
H 175

LED 8W Frame Options page 160 - 167

Standard Suspensions



Single Recessed



Single Round



3 Lights Round



5 Lights Round



2 Lights Radial



4 Lights Radial



4 Lights Rectangular



6 Lights Rectangular

Raise & Fall Suspensions



Single Round



3 Lights Round



4 Lights Rectangular



5 Lights Rectangular

Modular Suspension



Track 48V

Table Bases



Base Round



Base Round

LED 14W Frame Options page 168 - 173

Standard Suspensions



Single Round



3 Lights Round



3 Lights Rectangular

Raise & Fall Suspensions



Single Round



3 Lights Round



3 Lights Rectangular

Modular Suspension



Track 48V

Table Base



Base Round

libra



Il design essenziale di questo diffusore in vetro valorizza la purezza del materiale, creando riflessi morbidi e luminosi che arricchiscono l'ambiente senza appesantirlo. La finitura a specchio dona un tocco contemporaneo e raffinato, mentre la forma semplice lo rende estremamente versatile, adatto sia a contesti moderni che più classici. Un elemento discreto ma distintivo, capace di integrarsi con naturalezza in diversi stili di arredo.



The essential design of this glass diffuser enhances the purity of the material, creating soft, luminous reflections that enrich the space without overwhelming it.. The mirror finish adds a contemporary and refined touch, while the simple shape makes it extremely versatile, suitable for both modern and more classic settings. A discreet and distinctive element, capable of integrating effortlessly into various furnishing styles.



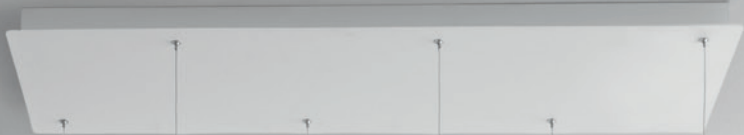

Diffusore in vetro in tre dimensioni: due per l'8W e uno per il 14W, tutti in 4 varianti colore compatibili con molteplici montature a sospensione, singole o multiple, e da tavolo.

Glass diffuser in three sizes: two for the 8W and one for the 14W, all in 4 color variants compatible with multiple suspension frames—single or multiple—as well as for table modular system.



LED 8W

LED 8W

LED 14W



3804-54-365



3804-55-365



3805-55-365

126 Fumè - Transparent grey

189 Oro - Gold

241 Trasparente - Transparent

365 Cognac



Ø 150
H 142



Ø 200
H 193

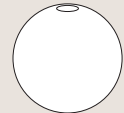

Ø 250
H 240

LED 8W Frame Options page 160 - 167

Standard Suspensions



Single Recessed Single Round 3 Lights Round 5 Lights Round 2 Lights Radial 4 Lights Radial 4 Lights Rectangular 6 Lights Rectangular

Raise & Fall Suspensions



Single Round 3 Lights Round 4 Lights Rectangular 5 Lights Rectangular

Modular Suspension



Track 48V

Table Bases



Base Round Base Round

LED 14W Frame Options page 168 - 173

Standard Suspensions



Single Round 3 Lights Round 3 Lights Rectangular

Raise & Fall Suspensions



Single Round 3 Lights Round

Modular Suspension



3 Lights Rectangular



Track 48V

Table Base



Base Round

ariel



Vetro sferico completamente trasparente, essenziale nella forma ma arricchito da un dettaglio interno sorprendente. All'interno della sfera prende vita una figura in vetro – una goccia, un cuore, un pesce o una farfalla – sospesa con leggerezza e perfettamente integrata nel volume. La totale trasparenza esalta la purezza del materiale e crea giochi di luce delicati, mettendo in risalto il dettaglio interno come un piccolo elemento scultoreo.



Completely transparent spherical glass, essential in form and enriched by a surprising internal detail. Inside the sphere, a glass figure comes to life—a drop, a heart, a fish, or a butterfly—lightly suspended and perfectly integrated within the volume. The total transparency enhances the purity of the material and creates delicate plays of light, highlighting the interior detail as a small sculptural element.







Diffusore in vetro con goccia in due dimensioni: uno per l'8W e uno per il 14W; diffusore in vetro con inserto colorato solo per l'8W. Tutte le sfere sono mixabili e compatibili con molteplici montature a sospensione, singole o multiple, e da tavolo.

Glass diffuser with internal drop available in two sizes: one for the 8W and one for the 14W; glass diffuser with colored insert available only for 8W. All spheres are mix-and-match and compatible with multiple suspension frames—single or multiple—as well as for table modular system.



LED 8W

LED 14W



3804-51-372



3805-51-372



372 Trasparente/goccia - Transparent/drop



Ø 150
H 143

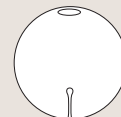

Ø 250
H 240

LED 8W Frame Options page 160 - 167

Standard Suspensions



Single Recessed Single Round 3 Lights Round 5 Lights Round 2 Lights Radial 4 Lights Radial 4 Lights Rectangular 6 Lights Rectangular

Raise & Fall Suspensions



Single Round 3 Lights Round 4 Lights Rectangular 5 Lights Rectangular Track 48V

Table Bases



Base Round Base Round

LED 14W Frame Options page 168 - 173

Standard Suspensions



Single Round 3 Lights Round 3 Lights Rectangular

Raise & Fall Suspensions



Single Round 3 Lights Round

Modular Suspension



3 Lights Rectangular

Track 48V

Table Base



Base Round

LED 8W



3804-51-369



3804-51-370



3804-51-371



369 Trasparente/cuore - Transparent/heart



370 Trasparente/farfalla - Transparent/butterfly



371 Trasparente/pesce - Transparent/fish



Ø 150
H 143

LED 8W Frame Options page 160 - 167

Standard Suspensions



Single Recessed



Single Round



3 Lights Round



5 Lights Round



2 Lights Radial



4 Lights Radial



4 Lights Rectangular



6 Lights Rectangular

Raise & Fall Suspensions



Single Round



3 Lights Round



4 Lights Rectangular



5 Lights Rectangular

Modular Suspension



Track 48V

Table Bases



Base Round



Base Round

dervio



Vetro sferico interamente bianco lucido, dalla presenza morbida e luminosa, caratterizzato da un taglio alla base che ne interrompe la perfetta rotondità. Questo dettaglio da cui fuoriesce la luce è integrato con discrezione nel taglio inferiore, diventando parte del disegno e contribuendo a una diffusione morbida e uniforme.

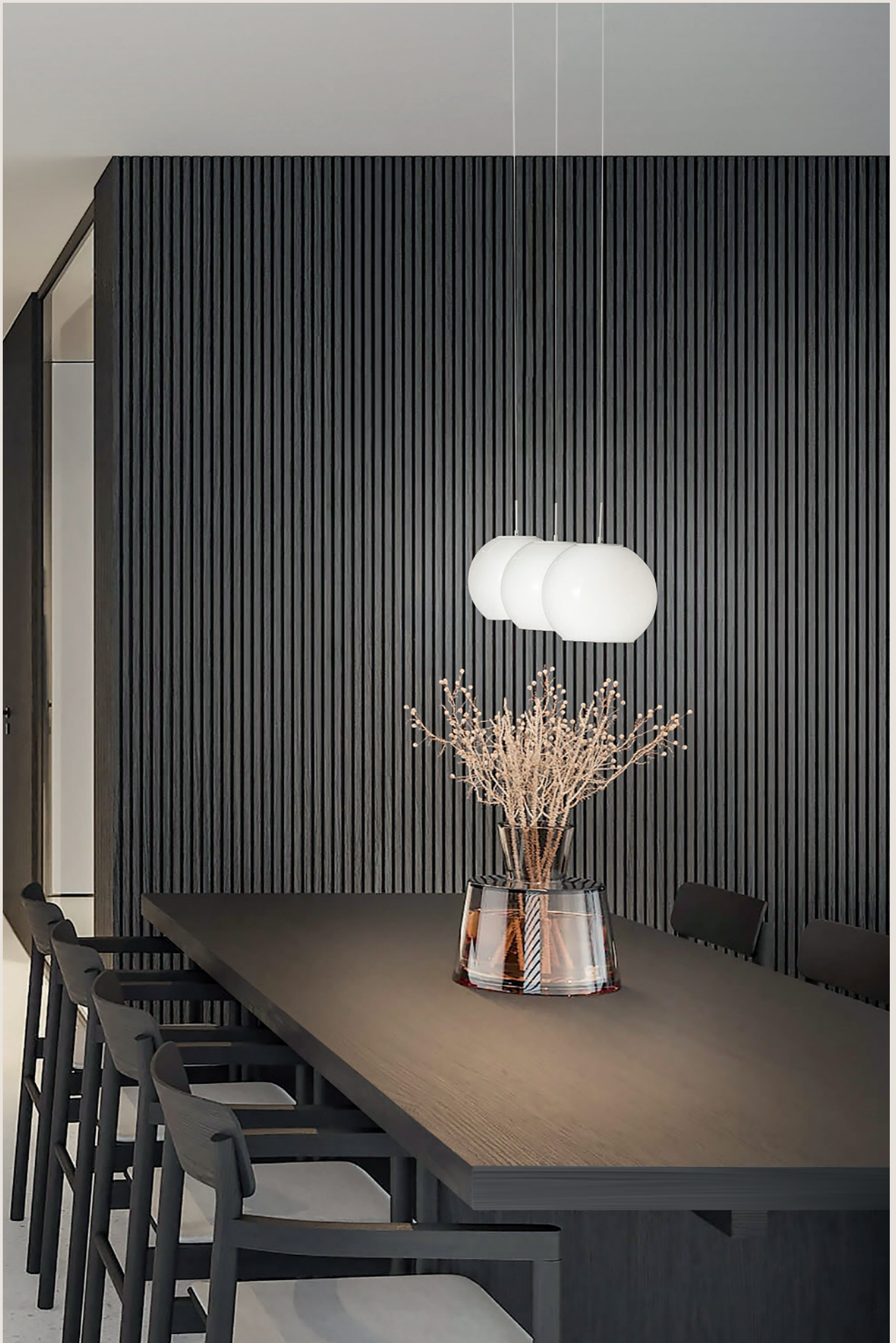



Spherical, entirely glossy white glass, with a soft, luminous appearance, defined by a cut at the base that interrupts its perfect roundness. This detail, from which the light emerges, is discreetly integrated into the lower cut, becoming part of the design and contributing to a soft, uniform diffusion of light.





Diffusore in vetro in due dimensioni: uno per l'8W e uno per il 14W in una variante colore; compatibili con molteplici montature a sospensione, singole o multiple, e da tavolo.

Glass diffuser available in two sizes: one for the 8W and one for the 14W, in one color variant, compatible with multiple suspension frames—single or multiple—as well as for table modular system.

LED 8W

LED 14W



3804-53-102



3805-53-102

 **102 Bianco - White**

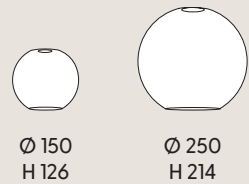

LED 8W Frame Options page 160 - 167

Standard Suspensions



Single Recessed Single Round 3 Lights Round 5 Lights Round 2 Lights Radial 4 Lights Radial 4 Lights Rectangular 6 Lights Rectangular

Raise & Fall Suspensions



Single Round 3 Lights Round 4 Lights Rectangular 5 Lights Rectangular

Modular Suspension



Track 48V

Table Bases



Base Round Base Round

LED 14W Frame Options page 168 - 173

Standard Suspensions



Single Round 3 Lights Round 3 Lights Rectangular

Raise & Fall Suspensions



Single Round 3 Lights Round

Modular Suspension



3 Lights Rectangular Track 48V

Table Base



Base Round

devero



Vetro dalla forma ellittica, completamente chiuso e dal volume armonioso, pensato per valorizzare la luce con eleganza e continuità. La superficie esterna, disponibile in tonalità specchiate - trasparenti, riflette l'ambiente con raffinatezza, mentre la parte inferiore satinata crea un punto luminoso morbido e controllato, da cui la luce fuoriesce in modo delicato. Il contrasto tra la finitura lucida e quella satinata aggiunge profondità e carattere al vetro, mantenendo un'estetica pulita e contemporanea.



Elliptical glass, completely enclosed and with a harmonious volume, designed to enhance the light with elegance and continuity. The outer surface, available in mirrored-transparent shades, elegantly reflects the environment, while the satin-finished lower surface creates a soft, controlled light source, from which the light emanates delicately. The contrast between the glossy and satin finishes adds depth and character to the glass, maintaining a clean, contemporary aesthetic.



Diffusore in vetro in due finiture colore compatibile con le montature 8W sia a sospensione, singole o multiple, sia da tavolo.

Glass diffuser available in two color finishes, compatible with 8W suspension frame -single or multiple—as well as for table modular system.

LED 8W



3823-50-378

 **378** Cognac sfumato - Shaded cognac

 **379** Grigio chiaro sfumato - Shaded light grey



Ø 250
H 130

LED 8W Frame Options page 160 - 167

Standard Suspensions



Single Recessed Single Round 3 Lights Round 5 Lights Round 2 Lights Radial 4 Lights Radial 4 Lights Rectangular 6 Lights Rectangular

Raise & Fall Suspensions



Single Round 3 Lights Round 4 Lights Rectangular 5 Lights Rectangular

Modular Suspension



Track 48V

Table Bases



Base Round Base Round



FRUO



Diffusore composto da due volumi in vetro sovrapposti, pensato per creare un raffinato dialogo tra luce e materia. All'interno, un vetro satinato dalla forma definita avvolge la sorgente luminosa, ammorbidendo l'emissione e garantendo una diffusione uniforme e confortevole. All'esterno, un vetro più trasparente racchiude il tutto, valorizzando il disegno e lasciando percepire la stratificazione dei materiali. Il contrasto tra le diverse finiture aggiunge profondità e carattere, dando vita a un oggetto elegante e contemporaneo, equilibrato tra funzione tecnica e valore estetico.



A diffuser composed of two overlapping glass volumes, designed to create a refined dialogue between light and material. Inside, a satin-finished glass element with a defined shape surrounds the light source, softening the emission and ensuring uniform and comfortable diffusion. On the outside, a more transparent glass layer encloses the whole, enhancing the design and allowing the layered construction of the materials to be perceived. The contrast between the different finishes adds depth and character, creating an elegant and contemporary object, balanced between technical performance and aesthetic value.



Diffusore in vetro in due finiture colore compatibile con le montature 8W sia a sospensione, singole o multiple, sia da tavolo.

Glass diffuser available in two color finishes, compatible with 8W suspension frame –single or multiple– as well as for table modular system.

LED 8W



3823-51-365



365 Cognac - Cognac



377 Grigio chiaro trasparente - Transparent light grey



Ø 180
H 165

LED 8W Frame Options page 160 - 167

Standard Suspensions



Single Recessed



Single Round



3 Lights Round



5 Lights Round



2 Lights Radial



4 Lights Radial



4 Lights Rectangular



6 Lights Rectangular

Raise & Fall Suspensions



Single Round



3 Lights Round



4 Lights Rectangular



5 Lights Rectangular

Modular Suspension



Track 48V

Table Bases



Base Round



Base Round

Lucille



Vetro dalla linea morbida che dona alla forma un'eleganza naturale e contemporanea. La superficie superiore è liscia e uniforme, mentre nella parte inferiore, in corrispondenza della chiusura, compare una raffinata finitura martellata. Questo dettaglio materico crea un delicato gioco di riflessi e trasparenze, arricchendo la luce e conferendo un design ricercato ma versatile, capace di unire semplicità e personalità.



Glass with a soft line that gives the shape a natural and contemporary elegance. The upper surface is smooth and uniform, while the lower section, at the closure, features a refined hammered finish. This material detail creates a delicate interplay of reflections and transparency, enriching the light and giving the design a refined yet versatile character, capable of combining simplicity with personality.



Diffusore in vetro in due finiture colore compatibile con le montature 8W sia a sospensione, singole o multiple, sia da tavolo.

Glass diffuser available in two color finishes, compatible with 8W suspension frame -single or multiple—as well as for table modular system.

LED 8W



3804-59-365



126 Fumè - Transparent grey



365 Cognac - Cognac



Ø 160
 H 90

LED 8W Frame Options page 160 - 167

Standard Suspensions



Single Recessed



Single Round



3 Lights Round



5 Lights Round



2 Lights Radial



4 Lights Radial



4 Lights Rectangular



6 Lights Rectangular

Raise & Fall Suspensions



Single Round



3 Lights Round



4 Lights Rectangular



5 Lights Rectangular

Modular Suspension



Track 48V

Table Bases



Base Round



Base Round

brenna



Vetro dalla forma elegante e armoniosa, che introduce una nota distintiva mantenendo uno stile sobrio e contemporaneo. La superficie liscia accompagna la luce con riflessi delicati, mentre la parte inferiore, leggermente rientrante e satinata, crea un raffinato contrasto materico. Questo dettaglio aggiunge profondità visiva, valorizzando la forma senza rinunciare alla semplicità.



Glass with an elegant and harmonious shape, introducing a distinctive accent while maintaining a simple and contemporary style. The smooth surface accompanies the light with delicate reflections, while the slightly recessed, satin-finished lower section creates a refined material contrast. This detail adds visual depth, enhancing the shape without compromising its simplicity.







Diffusore in vetro in due dimensioni: uno per l'8W e uno per il 14W, entrambe in 2 varianti colore compatibili con molteplici montature a sospensione, singole o multiple, e da tavolo.

Glass diffuser in two sizes: one for the 8W and one for the 14W, both in 2 color variants compatible with multiple suspension frames—single or multiple—as well as for table modular system.

LED 8W

LED 14W



3804-52-365



3805-52-365

 **241** Trasparente - Transparent

 **365** Cognac - Cognac



Ø 180
H 100



Ø330
H 195

LED 8W Frame Options page 160 - 167

Standard Suspensions



Single Recessed Single Round 3 Lights Round 5 Lights Round 2 Lights Radial 4 Lights Radial 4 Lights Rectangular 6 Lights Rectangular

Raise & Fall Suspensions



Single Round 3 Lights Round 4 Lights Rectangular 5 Lights Rectangular

Modular Suspension



Track 48V

Table Bases



Base Round Base Round

LED 14W Frame Options page 168 - 173

Standard Suspensions



Single Round 3 Lights Round 3 Lights Rectangular

Raise & Fall Suspensions



Single Round 3 Lights Round

Modular Suspension



3 Lights Rectangular



Track 48V

Table Base



Base Round

croodo



Vetro dal volume morbido e armonioso, pensato esclusivamente per lampade da tavolo e caratterizzato da un design originale e funzionale. All'interno del corpo in vetro è possibile inserire una sottile provetta, pensato per accogliere piccoli fiori o profumatori, trasformando la lampada in un elemento decorativo vivo e personale. Un oggetto che unisce luce e natura in modo discreto e raffinato, capace di arricchire l'ambiente con un dettaglio poetico e inatteso.



Glass with a soft, harmonious volume, designed exclusively for table lamps and defined by an original, functional design. A slender glass vial can be inserted inside the glass body, designed to hold small flowers or fragrance diffusers, transforming the lamp into a living, personal decorative element. An object that discreetly and elegantly combines light and nature, in a discreet and refined way, capable of enriching the environment with a poetic and unexpected detail.



Diffusore in vetro, in tre finiture colore, compatibile con le basi da tavolo 8W.

Glass diffuser available in three color finishes, compatible with 8W table lamp bases.

LED 8W



3823-52-365

 **107** Ametista - Amethyst

 **365** Cognac

 **377** Grigio chiaro trasparente - Transparent light grey



Ø 190
H 205



Provetta inclusa - Tube included

LED 8W Structure Options page 167

Table Bases



tully



Vetro ovale dal segno pulito ed equilibrato, progettato per lampade da tavolo e completato da un dettaglio interno raffinato. L'accessorio in vetro, pensato per accogliere piccoli fiori o profumatori, presenta una forma ovale allungata, elegante e slanciata, che introduce un elemento distintivo senza alterare l'armonia complessiva. La trasparenza e le finiture specchiate del vetro esterno dialogano con la luce, creando riflessi morbidi e un'illuminazione avvolgente.



Oval glass with a clean and balanced design, created for table lamps and complemented by a refined internal detail. The glass accessory, designed to hold small flowers or fragrance diffusers, features an elongated, elegant, and slender oval shape, introducing a distinctive element without disrupting the overall harmony. The transparency and mirrored finishes of the outer glass interact with the light, creating soft reflections and an enveloping illumination.



Diffusore in vetro, in tre finiture colore, compatibile con le basi da tavolo 8W.

Glass diffuser available in three color finishes, compatible with 8W table lamp bases.

LED 8W



3823-54-365

 **107** Ametista - Amethyst

 **365** Cognac

 **377** Grigio chiaro trasparente - Transparent light grey



Ø 160
H 215



Provetta inclusa - Tube included

LED 8W Structure Options page 167

Table Bases



wengen



Vetro sferico dal design essenziale e bilanciato, pensato esclusivamente per lampade da tavolo e arricchito da un dettaglio funzionale e decorativo. All'interno della sfera è possibile inserire una sottile provetta, ideata per accogliere piccoli fiori o profumatori, che aggiunge una nota naturale e personale all'oggetto. La finitura del vetro, disponibile in versioni trasparenti e specchiate, valorizza la luce con riflessi delicati e un'emissione morbida e avvolgente.



Spherical glass with a simple and balanced design, created exclusively for table lamps and enhanced by a functional and decorative detail. A slender glass vial can be inserted inside the glass body, designed to hold small flowers or fragrance diffusers, adding a natural and personal touch to the object. The glass finish, available in transparent and mirrored versions, enhances the light with delicate reflections and a soft, enveloping glow.



Diffusore in vetro, in tre finiture colore, compatibile con le basi da tavolo 8W.

Glass diffuser available in three color finishes, compatible with 8W table lamp bases.

LED 8W



3823-53-365

 **107** Ametista - Amethyst

 **365** Cognac

 **377** Grigio chiaro trasparente - Transparent light grey

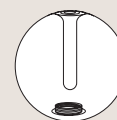

Ø 195



Provetta inclusa - Tube included

LED 8W Structure Options page 167

Table Bases



colico



Una forma circolare ampia e sottile, dal profilo piatto e ben definito caratterizza questo diffusore in metallo. Il volume leggermente ribassato e l'apertura centrale conferiscono all'elemento un'estetica pulita e contemporanea, pensata per una presenza discreta ma equilibrata. La superficie esalta la precisione del materiale, mentre la luce viene diffusa in modo uniforme, creando un effetto luminoso morbido e controllato. Un diffusore dal carattere tecnico ed elegante, ideale per ambienti moderni e per installazioni che richiedono ordine formale e coerenza visiva.



A wide, thin circular shape with a flat, well-defined profile characterizes this metal diffuser. The slightly lowered volume and central opening give the element a clean, contemporary aesthetic, designed for a discreet and balanced presence. The continuous surface enhances the precision of the material, while the light is diffused uniformly, creating a soft, controlled lighting effect. A diffuser with a technical and elegant character, ideal for modern spaces and installations that require formal order and visual coherence.



Diffusore in metallo in due dimensioni: uno per l'8W e uno per il 14W, in 6 varianti colore compatibili con molteplici montature a sospensione, singole o multiple.

Metal diffuser in two sizes: one for the 8W and one for the 14W, in 6 color variants compatible with multiple suspension frames, single or multiple.

LED 8W

LED 14W



3804-58-375



3805-58-375

ESTERNO - EXTERNAL

INTERNO - INTERNAL

	101 Nero - Black	Bianco - White
	102 Bianco - White	Bianco - White
	288 Grigio - Grey	Bianco - White
	355 Sabbia - Sand	Bianco - White
	374 Blu avio - Aviation blue	Bianco - White
	375 Rosso mattone - Brick red	Bianco - White

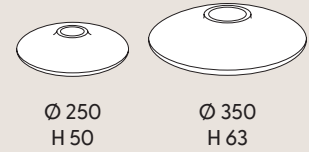

LED 8W Frame Options page 160 - 167

Standard Suspensions

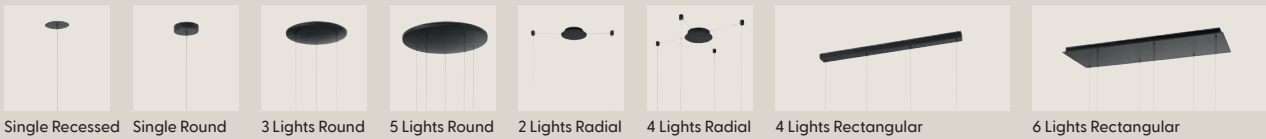

Raise & Fall Suspensions

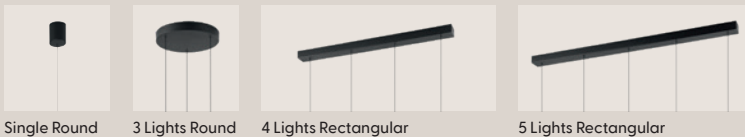

Modular Suspension



LED 14W Frame Options page 168 - 173

Standard Suspensions



Raise & Fall Suspension



Modular Suspension



Solda



Il design essenziale di questo diffusore in metallo si esprime attraverso una forma cilindrica compatta e proporzionata, dal carattere solido e pulito. Il volume regolare e l'apertura centrale definiscono una geometria precisa ed equilibrata, pensata per un'integrazione discreta e ordinata nell'ambiente. Un elemento sobrio e versatile, progettato per garantire continuità visiva e coerenza formale in diverse configurazioni di installazione.



The essential design of this metal diffuser is expressed through a compact, well-proportioned cylindrical form, with a solid and clean character. The regular volume and central opening define a precise, balanced geometry, designed for discreet and orderly integration into the environment. A sober and versatile element, conceived to ensure visual continuity and formal coherence across different installation configurations.



Diffusore in metallo in due dimensioni: uno per l'8W e uno per il 14W, in 6 varianti colore compatibili con molteplici montature a sospensione, singole o multiple.

Metal diffuser in two sizes: one for the 8W and one for the 14W, in 6 color variants compatible with multiple single frames, single or multiple.

LED 8W

LED 14W



3804-57-375

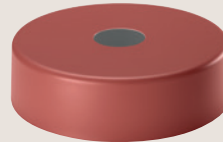

3805-57-375

ESTERNO - EXTERNAL

INTERNO - INTERNAL

	101 Nero - Black	Bianco - White
	102 Bianco - White	Bianco - White
	288 Grigio - Grey	Bianco - White
	355 Sabbia - Sand	Bianco - White
	374 Blu avio - Aviation blue	Bianco - White
	375 Rosso mattone - Brick red	Bianco - White

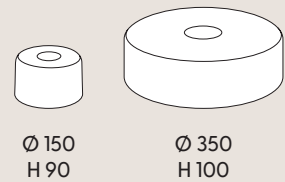

LED 8W

Frame Options page 160 - 167

Standard Suspensions

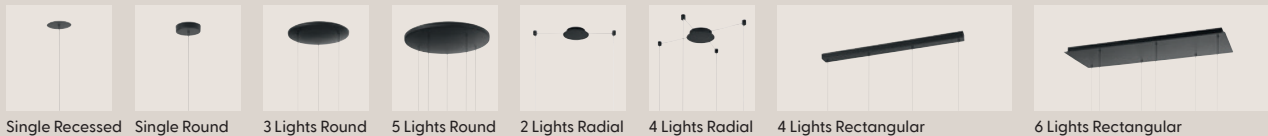

Raise & Fall Suspensions



Modular Suspension



LED 14W

Frame Options page 168 - 173

Standard Suspensions



Raise & Fall Suspension



Modular Suspension



varone



Il design essenziale di questo diffusore in metallo si caratterizza per una forma circolare ribassata, con un profilo leggermente inclinato che alleggerisce il volume e ne accentua la pulizia formale. L'apertura centrale definisce la struttura con precisione, mentre la superficie liscia e continua valorizza la purezza del materiale. La luce viene diffusa in modo uniforme e controllato, creando un effetto luminoso discreto e funzionale. Un diffusore dal linguaggio sobrio e contemporaneo, ideale per installazioni ordinate e ambienti dal carattere architettonico.



The essential design of this metal diffuser is characterized by a low circular shape, with a slightly inclined profile that lightens the volume and accentuates its clean lines. The central opening precisely defines the structure, while the smooth, continuous surface enhances the purity of the material. The light is diffused uniformly and in a controlled manner, creating a discreet and functional lighting effect. A diffuser with a sober and contemporary aesthetic, ideal for orderly installations and environments with a strong architectural character.



Diffusore in metallo in due dimensioni: uno per l'8W e uno per il 14W, in 6 varianti colore compatibili con molteplici montature a sospensione, singole o multiple.

Metal diffuser in two sizes: one for the 8W and one for the 14W, in 6 color variants compatible with multiple suspension frames, single or multiple

LED 8W

LED 14W

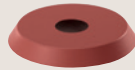

3804-56-375

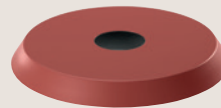

3805-56-375

ESTERNO/INTERNO - EXTERNAL/INTERNAL

- 101** Nero - Black

- 102** Bianco - White

- 288** Grigio - Grey

- 355** Sabbia - Sand

- 374** Blu avio - Aviation blue

- 375** Rosso mattone - Brick red

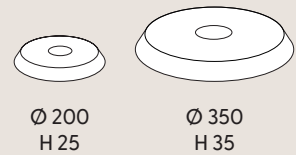

LED 8W Frame Options page 160 - 167

Standard Suspensions

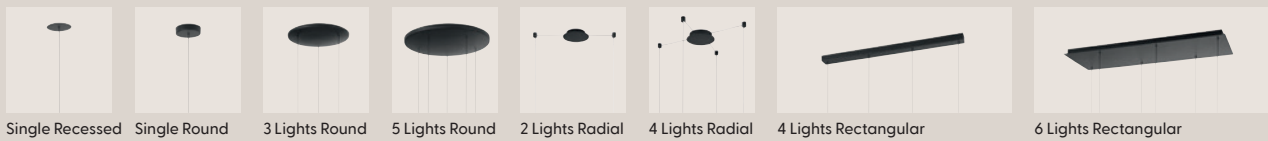

Raise & Fall Suspensions

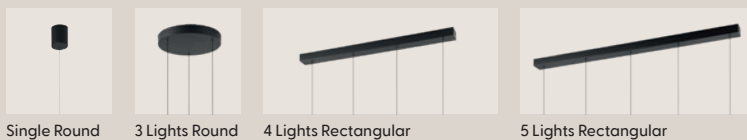

Modular Suspension



LED 14W Frame Options page 168 - 173

Standard Suspensions



Raise & Fall Suspension



Modular Suspension



Technical information

round frames



LED 8W Standard Suspensions

Montatura in metallo / Metal frame

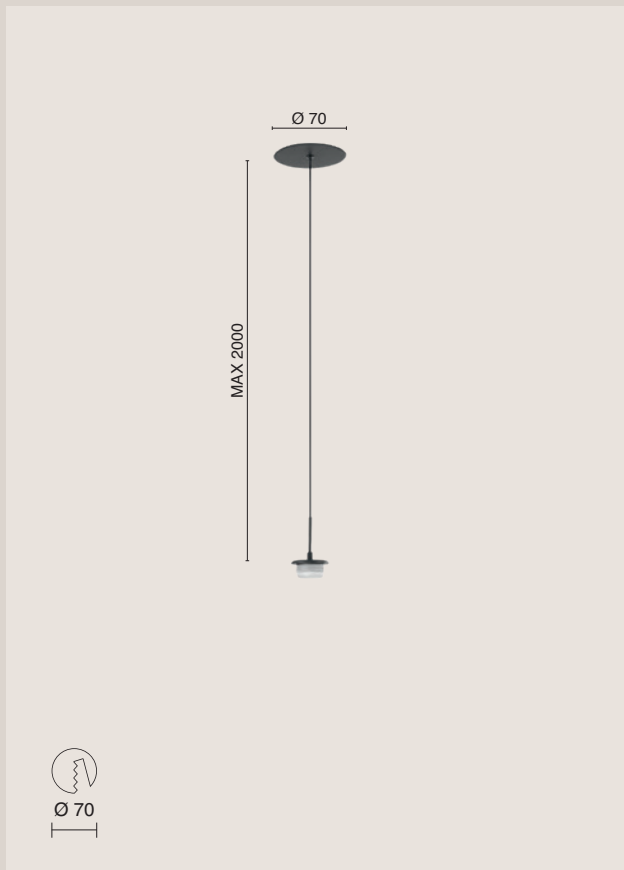

- ▲ Tonda 1 luce incasso
1 Light round recessed
8W - 750lm



- **3804-40-101**
Nero - Black
Cavo nero - Black cable

- **3804-40-102**
Bianco - White
Cavo trasparente - Transparent cable

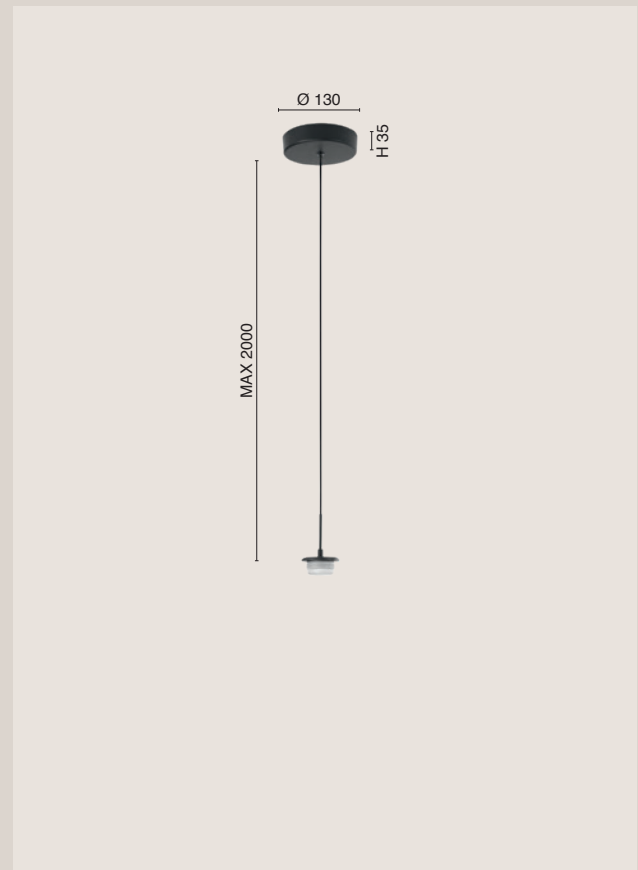

- ▲ Tonda 1 luce
1 Light round
8W - 750lm



- **3804-41-101**
Nero - Black
Cavo nero - Black cable

- **3804-41-102**
Bianco - White
Cavo trasparente - Transparent cable



Dimmerabile a step
Steps dimmable



2700K - 3000K - 4000K



Funzione di memoria
Memory function

Su richiesta è possibile fornire il cavo nella lunghezza desiderata. (MAX 8 m)
On request, the cable can be supplied in the desired length. (MAX 8 m)

Diffusori in vetro / Paralumi in metallo - Glass diffuser / Metal shade - page 68 - 159



Technical information

round frames

LED 8W Standard Suspensions

Montatura in metallo / Metal frame

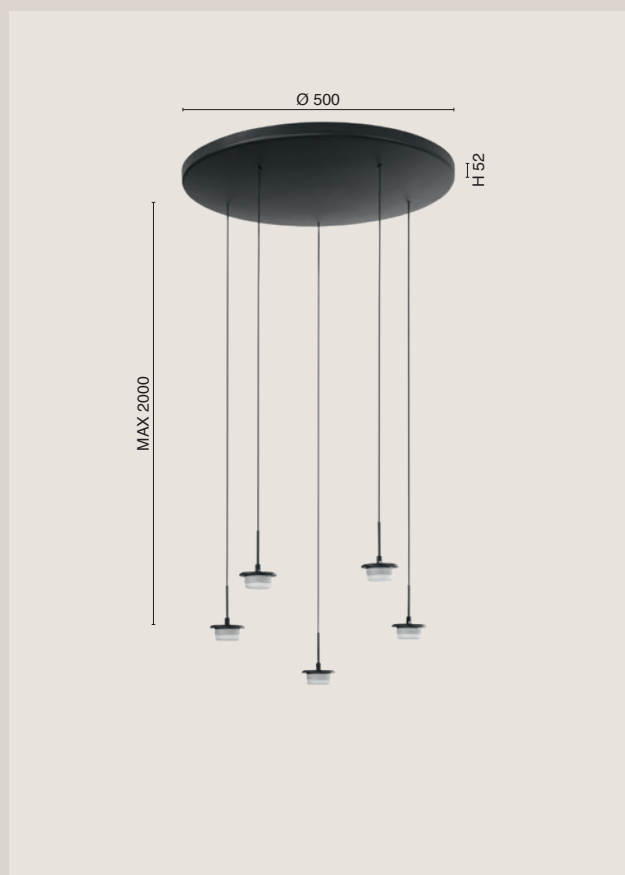
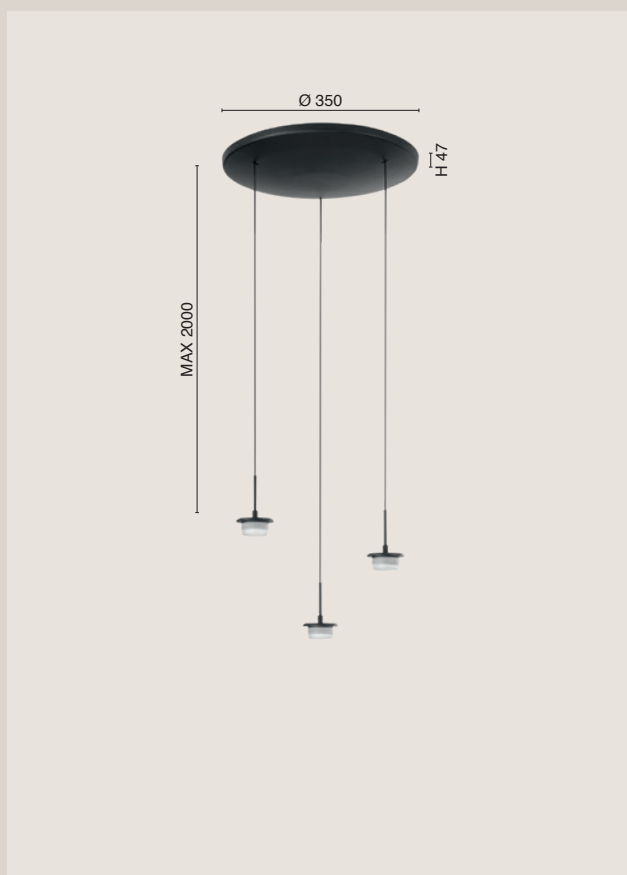

- ▲ Tonda 3 luci
3 Lights round
21W - 2250lm

- ▲ Tonda 5 luci
5 Lights round
35W - 3750lm

● **3804-47-101**
Nero - Black
Cavo nero - Black cable

● **3804-49-101**
Nero - Black
Cavo nero - Black cable

● **3804-47-102**
Bianco - White
Cavo trasparente - Transparent cable

● **3804-49-102**
Bianco - White
Cavo trasparente - Transparent cable

⚡ **Dimmerabile a step**
Steps dimmable

🌈 2700K - 3000K - 4000K

🧠 **Funzione di memoria**
Memory function

Su richiesta è possibile fornire il cavo nella lunghezza desiderata. (MAX 8 m)
On request, the cable can be supplied in the desired length. (MAX 8 m)

Diffusori in vetro / Paralumi in metallo - Glass diffuser / Metal shade - page 68 - 159

CE Ⓞ Ⓜ IP20

Technical information

round frames

LED 8W Standard Suspensions

Montatura in metallo / Metal frame

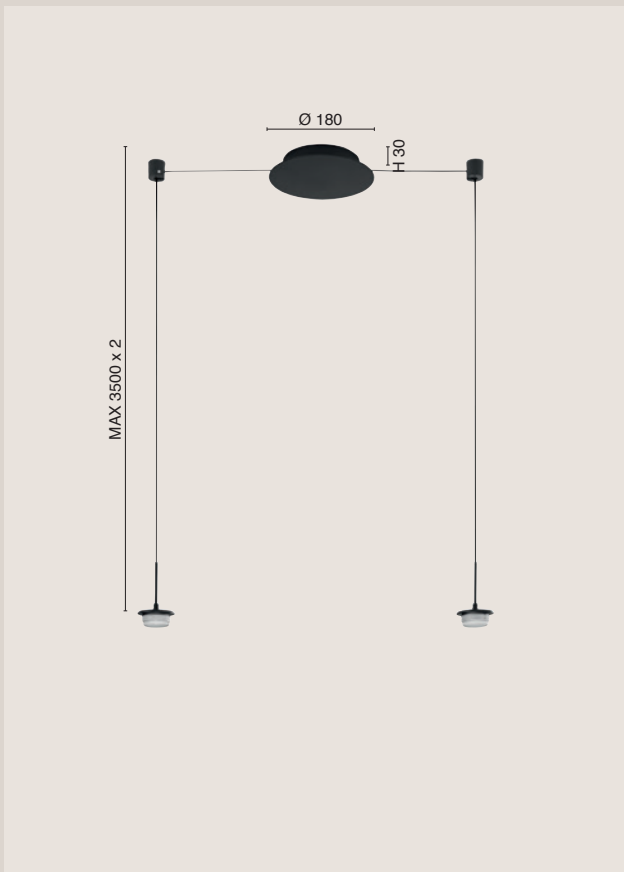

- ▲ Tondo radiale 2 luci
Radial round 2 lights
16W - 1500lm
2 supporti per cavo inclusi *
2 cable supports included *



3804-42-101
Nero - Black
Cavo nero - Black cable
*Accessorio Nero - Black accessory



3804-42-102
Bianco - White
Cavo trasparente - Transparent cable
*Accessorio Bianco - White accessory

- ▲ Tondo radiale 4 luci
Radial round 4 lights
28W - 3000lm
4 supporti per cavo inclusi *
4 cable supports included *



3804-44-101
Nero - Black
Cavo nero - Black cable
*Accessorio Nero - Black accessory



3804-44-102
Bianco - White
Cavo trasparente - Transparent cable
*Accessorio Bianco - White accessory



Dimmerabile a step
Steps dimmable



2700K - 3000K - 4000K



Funzione di memoria
Memory function

Su richiesta è possibile fornire il cavo nella lunghezza desiderata. (MAX 8 m)
On request, the cable can be supplied in the desired length. (MAX 8 m)

Diffusori in vetro / Paralumi in metallo - Glass diffuser / Metal shade - page 68 - 159



Technical information

rectangular frames

LED 8W Standard Suspensions

Montatura in metallo / Metal frame

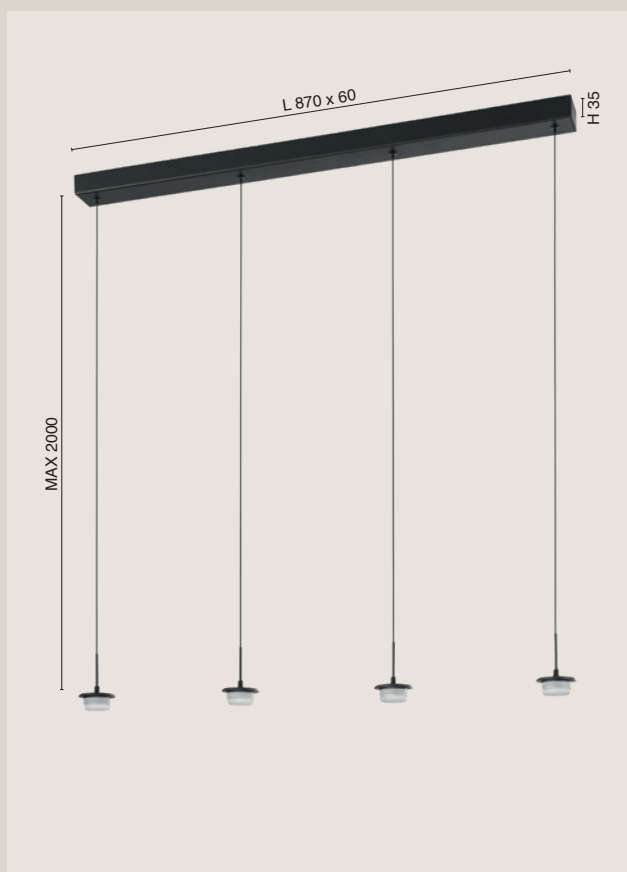

- ▲ Rettangolare 4 luci
4 Lights rectangular
28W - 3000lm

- ▲ Rettangolare 6 luci
6 Lights rectangular
42W - 4500lm

● **3804-48-101**
Nero - Black
Cavo nero - Black cable

● **3804-46-101**
Nero - Black
Cavo nero - Black cable

● **3804-48-102**
Bianco - White
Cavo trasparente - Transparent cable

● **3804-46-102**
Bianco - White
Cavo trasparente - Transparent cable

⚙️ **Dimmerabile a step**
Steps dimmable

🌈 2700K - 3000K - 4000K

🧠 **Funzione di memoria**
Memory function

Su richiesta è possibile fornire il cavo nella lunghezza desiderata. (MAX 8 m)
On request, the cable can be supplied in the desired length. (MAX 8 m)

Diffusori in vetro / Paralumi in metallo - Glass diffuser / Metal shade - page 68 - 159

CE Ⓞ Ⓜ IP20

Technical information

round frames

LED 8W Raise & Fall Suspension

Montatura in metallo / Metal frame

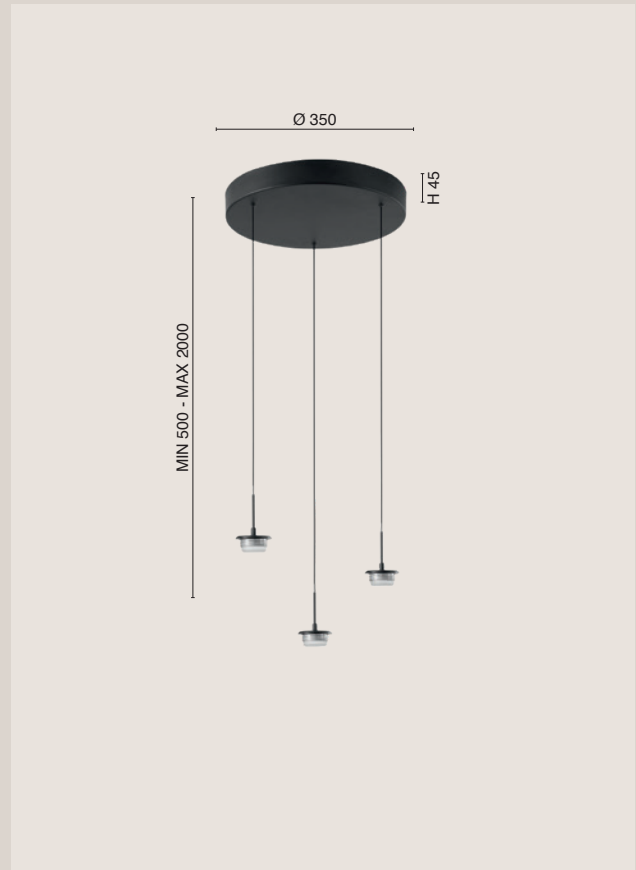
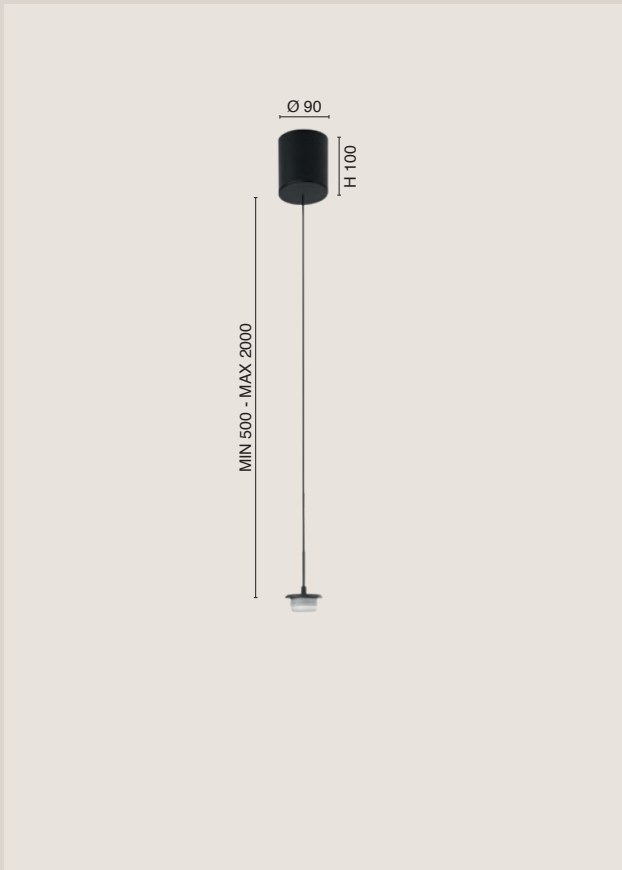

- ▲ Tonda 1 luce saliscendi
1 Light round Raise & fall
8W - 750lm

 **Raise & Fall**
MIN. 500mm - MAX 2000mm

 **3804-45-101**
Nero - Black
Cavo nero - Black cable

 **3804-45-102**
Bianco - White
Cavo trasparente - Transparent cable

- ▲ Tonda 3 luci saliscendi
3 Lights round Raise & fall
21W - 2550lm

 **Raise & Fall**
MIN. 500mm - MAX 2000mm

 **3806-45-42-101**
Nero - Black
Cavo nero - Black cable

 **3806-42-102**
Bianco - White
Cavo trasparente - Transparent cable

 **Dimmerabile a step**
Steps dimmable

 2700K - 3000K - 4000K

 **Funzione di memoria**
Memory function

Technical information

rectangular frames

LED 8W Raise & Fall Suspension

Montatura in metallo / Metal frame

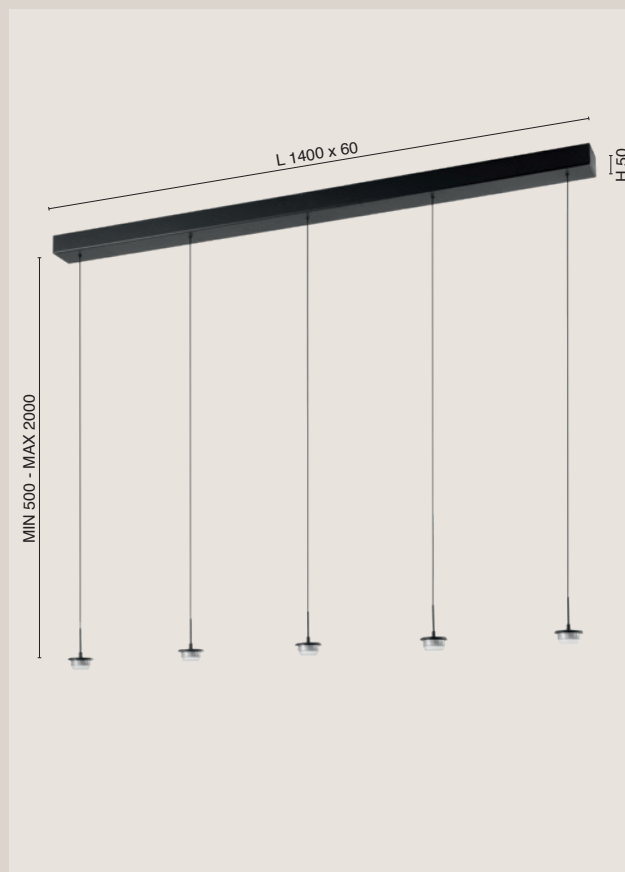
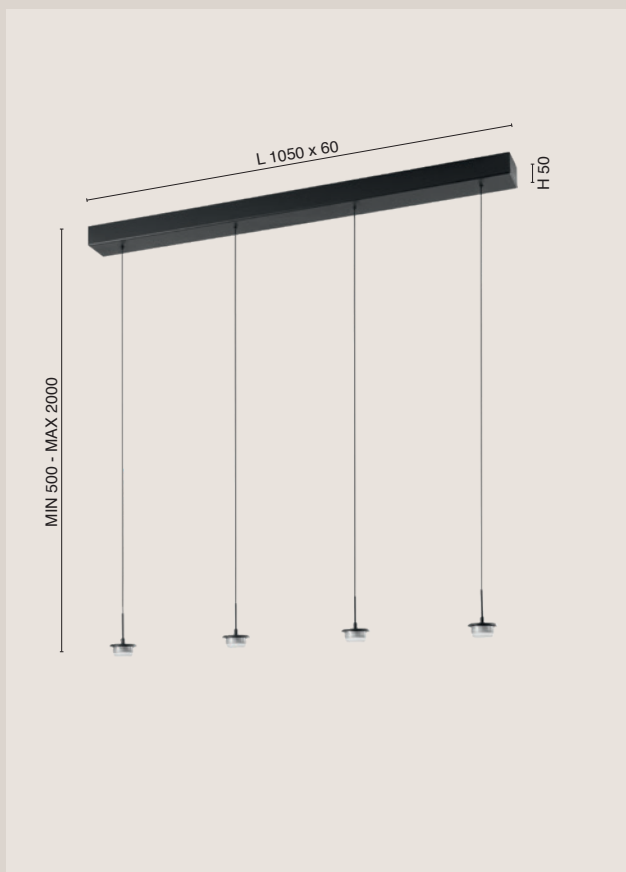

- ▲ Rettangolare 4 luci saliscendi
4 Lights rectangular Raise & fall
28W - 3000lm

 **Raise & Fall**
MIN. 500mm - MAX 2000mm

 **3806-44-101**
Nero - Black
Cavo nero - Black cable

 **3806-44-102**
Bianco - White
Cavo trasparente - Transparent cable

- ▲ Rettangolare 5 luci saliscendi
5 Lights rectangular Raise & fall
35W - 3750lm

 **Raise & Fall**
MIN. 500mm - MAX 2000mm

 **3806-45-101**
Nero - Black
Cavo nero - Black cable

 **3806-45-102**
Bianco - White
Cavo trasparente - Transparent cable

 **Dimmerabile a step**
Steps dimmable

 2700K - 3000K - 4000K

 **Funzione di memoria**
Memory function

Technical information
track 48V

LED 8W Modular Suspension

Montatura in metallo / Metal frame

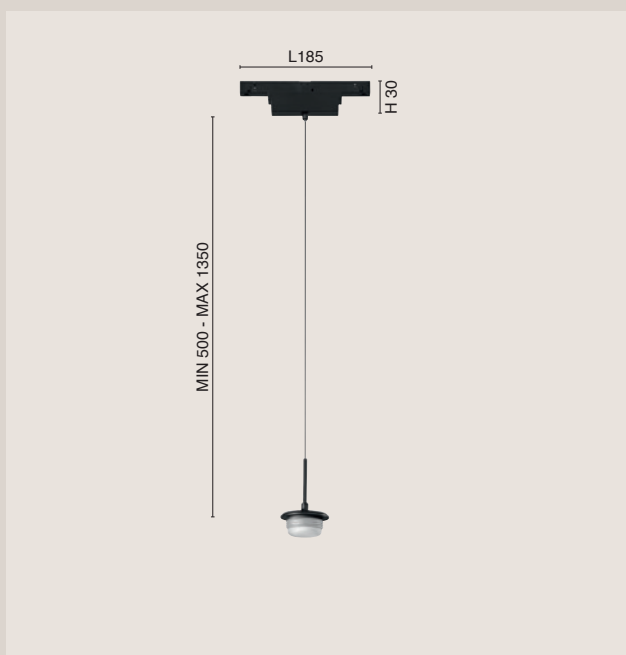
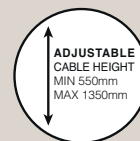

Adjustable cable

MIN. 550mm - MAX 1350mm

Consulta il catalogo - View catalogue
Technical Lighting



◀ Saliscendi Binario
Track Raise & fall

8W - 750lm

48V DC

Driver included

CRI >80



6525-56-011 ▶ On/Off

Nero - Black

Cavo nero - Black cable



6525-55-011 ▶ On/Off

Bianco - White

Cavo trasparente - Transparent cable



6525-56-014 ▶ DALI

Nero - Black

Cavo nero - Black cable



6525-55-014 ▶ DALI

Bianco - White

Cavo trasparente - Transparent cable



6525-56-016 ▶ Dimmer Push

Nero - Black

Cavo nero - Black cable



6525-55-016 ▶ Dimmer Push

Bianco - White

Cavo trasparente - Transparent cable



2700K - 3000K - 4000K



Funzione di memoria
Memory function

Su richiesta è possibile fornire il cavo nella lunghezza desiderata. (MAX 8 m)

On request, the cable can be supplied in the desired length. (MAX 8 m)

Diffusori in vetro / Paralumi in metallo - Glass diffuser / Metal shade - page 68 - 159



IP20





LED 8W Modular Table Lamp

Montatura in metallo / Metal structure



- ▲ Base Lume
Table Lamp Base
7W - 540lm



Funzione di memoria
Memory function

Cavo nero - Black cable



3823-90-101
Nero - Black



3823-90-102
Bianco - White



3823-90-115
Canna fucile - Gun metal



3823-90-119
Ottone satinato - Satined brass

- ▲ Base Lume
Table Lamp Base
7W - 540lm



Funzione di memoria
Memory function

Cavo nero - Black cable



3823-91-101
Nero - Black



3823-91-102
Bianco - White



3823-91-115
Canna fucile - Gun metal



3823-91-119
Ottone satinato - Satined brass



Dimmerabile a step
Steps dimmable



2700K - 3000K - 4000K



Funzione di memoria
Memory function

Technical information

round frames

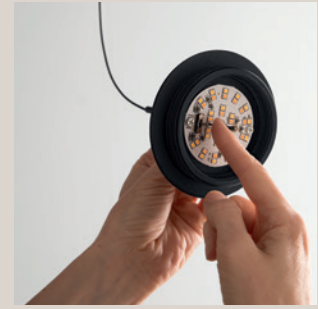

LED 14W Standard Suspensions

Montatura in metallo / Metal frame

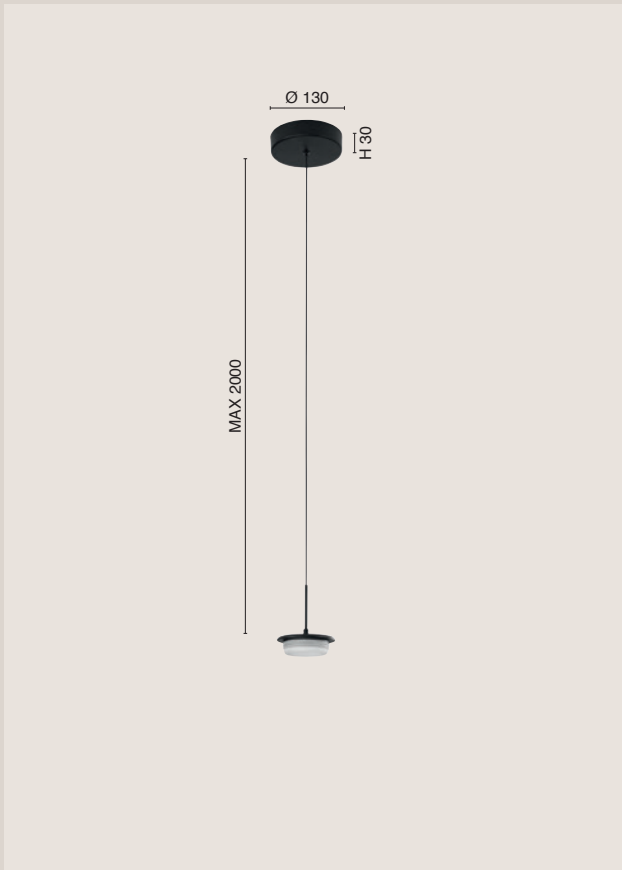

- ▲ Tonda 1 luce
1 Light round
14W - 1510lm

● **3805-41-101**
Nero - Black
Cavo nero - Black cable

● **3805-41-102**
Bianco - White
Cavo trasparente - Transparent cable



- ▲ Tonda 3 luci
3 Lights round
42W - 4530lm

● **3805-47-101**
Nero - Black
Cavo nero - Black cable

● **3805-47-102**
Bianco - White
Cavo trasparente - Transparent cable

⚡ **Dimmerabile a step**
Steps dimmable

🌈 **2700K - 3000K - 4000K**

🧠 **Funzione di memoria**
Memory function

Su richiesta è possibile fornire il cavo nella lunghezza desiderata. (MAX 8 m)
On request, the cable can be supplied in the desired length. (MAX 8 m)

Diffusori in vetro / Paralumi in metallo - Glass diffuser / Metal shade - page 68 - 159



Technical information

rectangular frames

LED 14W Standard Suspensions

Montatura in metallo / Metal frame

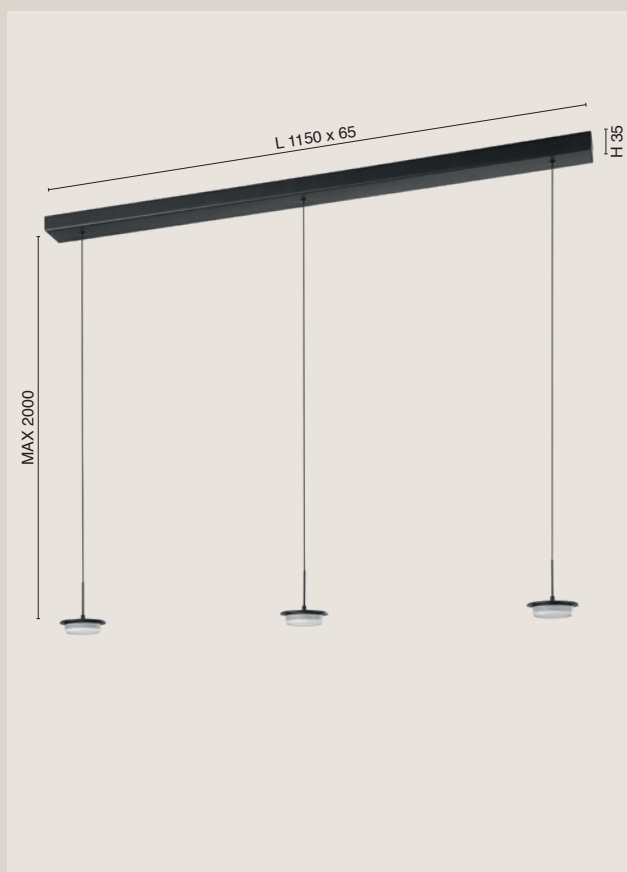

- ▲ Rettangolare 3 luci
3 Lights rectangular
42W - 4530lm

● **3805-48-101**
Nero - Black
Cavo nero - Black cable

● **3805-48-102**
Bianco - White
Cavo trasparente - Transparent cable

⚙️ **Dimmerabile a step**
Steps dimmable

🌈 **2700K - 3000K - 4000K**

🧠 **Funzione di memoria**
Memory function

Su richiesta è possibile fornire il cavo nella lunghezza desiderata. (MAX 8 m)
On request, the cable can be supplied in the desired length. (MAX 8 m)

Diffusori in vetro / Paralumi in metallo - Glass diffuser / Metal shade - page 68 - 159

CE Ⓞ Ⓜ IP20 A G E

Technical information

round frames

LED 14W Raise & fall Suspension

Montatura in metallo / Metal frame

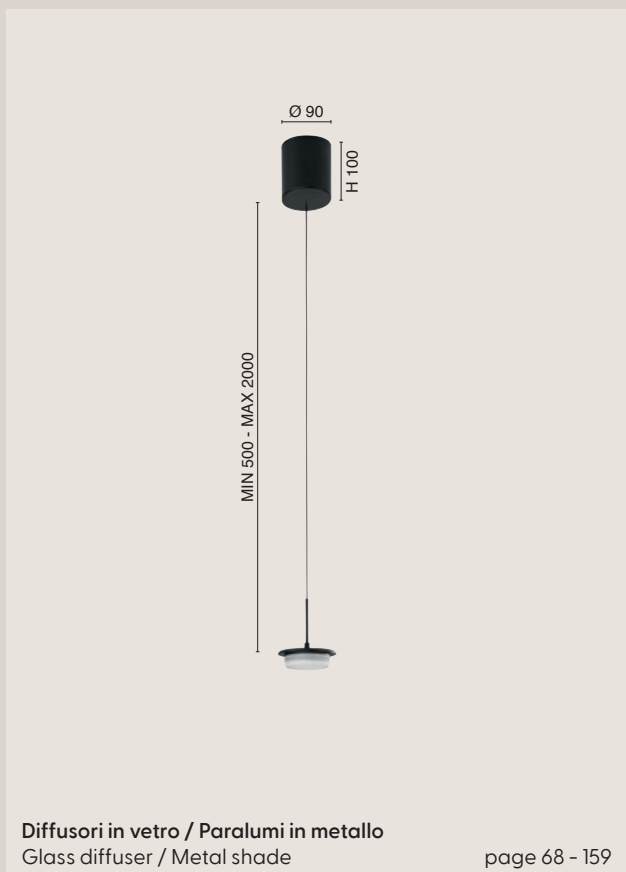
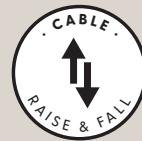

Diffusori in vetro / Paralumi in metallo
Glass diffuser / Metal shade

page 68 - 159

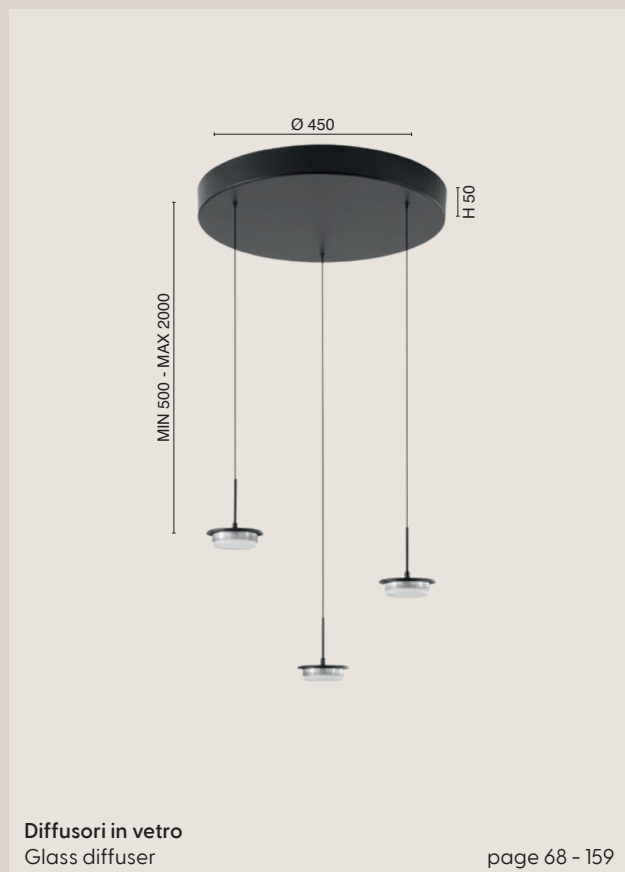

Diffusori in vetro
Glass diffuser

page 68 - 159

- ▲ Tonda 1 luce saliscendi
1 Light round Raise & fall
14W - 1510lm



Raise & Fall
MIN. 500mm - MAX 2000mm



3805-40-101
Nero - Black
Cavo nero - Black cable



3805-40-102
Bianco - White
Cavo trasparente - Transparent cable

- ▲ Tonda 3 luci saliscendi
3 Lights round Raise & fall
42W - 4530lm



Raise & Fall
MIN. 500mm - MAX 2000mm



3809-42-101
Nero - Black
Cavo nero - Black cable



3809-42-102
Bianco - White
Cavo trasparente - Transparent cable



Dimmerabile a step
Steps dimmable



2700K - 3000K - 4000K



Funzione di memoria
Memory function

Technical information

rectangular frames

LED 14W Raise & fall Suspension

Montatura in metallo / Metal frame

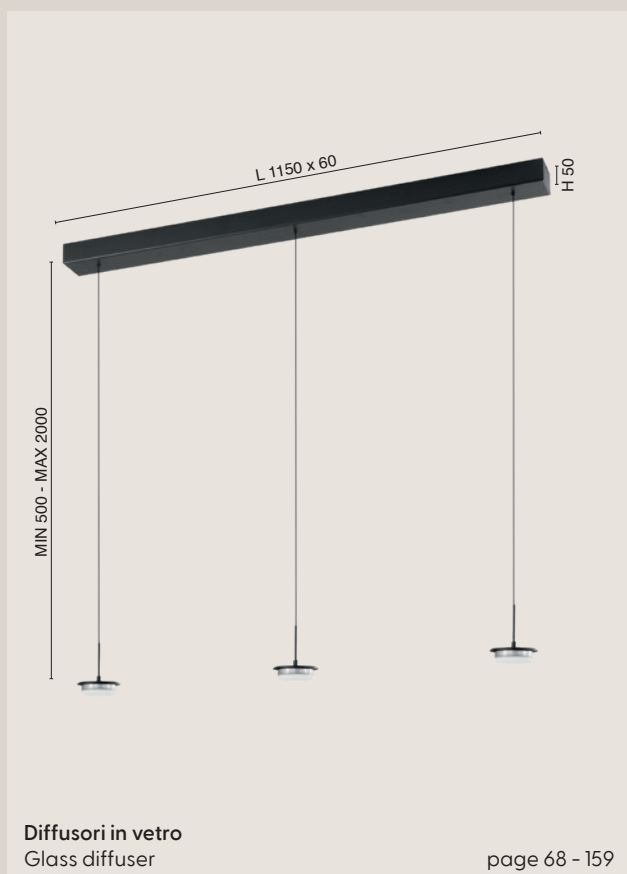

- ▲ Rettangolare 3 luci saliscendi
3 Lights rectangular Raise & fall
42W - 4530lm



Raise & Fall
MIN. 500mm - MAX 2000mm



3809-43-101
Nero - Black
Cavo nero - Black cable



3809-43-102
Bianco - White
Cavo trasparente - Transparent cable



Dimmerabile a step
Steps dimmable



2700K - 3000K - 4000K



Funzione di memoria
Memory function



IP20



Technical information
track 48V

LED 14W Modular Suspension

Montatura in metallo / Metal frame

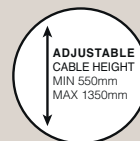

Adjustable cable

MIN. 550mm - MAX 1350mm

Consulta il catalogo - View catalogue
Technical Lighting



◀ Saliscendi Binario
Track Raise & fall

14W - 1510lm
48V DC
Driver included
CRI >80



6525-56-012 ▶ On/Off

Nero - Black

Cavo nero - Black cable



6525-55-012 ▶ On/Off

Bianco - White

Cavo trasparente - Transparent cable



6525-56-015 ▶ DALI

Nero - Black

Cavo nero - Black cable



6525-55-015 ▶ DALI

Bianco - White

Cavo trasparente - Transparent cable



6525-56-017 ▶ Dimmer Push

Nero - Black

Cavo nero - Black cable



6525-55-017 ▶ Dimmer Push

Bianco - White

Cavo trasparente - Transparent cable

2700K - 3000K - 4000K



Funzione di memoria
Memory function

Su richiesta è possibile fornire il cavo nella lunghezza desiderata. (MAX 8 m)

On request, the cable can be supplied in the desired length. (MAX 8 m)

Diffusori in vetro / Paralumi in metallo - Glass diffuser / Metal shade - page 68 - 159



IP20



LED 14W Modular Table Lamp

Montatura in metallo / Metal structure



- ◀ Base Lume
Table Lamp Base
11W - 1080 lm
-  Funzione di memoria
Memory function
- Cavo nero - Black cable
-  **3823-92-101**
Nero - Black
-  **3823-92-102**
Bianco - White
-  **3823-92-115**
Canna fucile - Gun metal
-  **3823-92-119**
Ottone satinato - Satined brass



Dimmerabile a step
Steps dimmable



2700K - 3000K - 4000K



Funzione di memoria
Memory function



IP20



Technical information

accessories

LED

Accessori in metallo / Metal accessories

Supporto aggiuntivo per fissaggio cavo
Additional support for cable fixing



MPIN1013685
Nero - Black

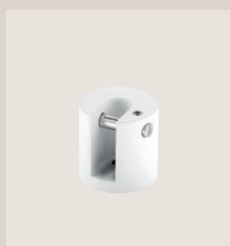

MPIN1023685
Bianco - White

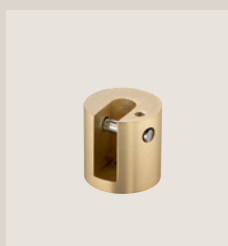

MPIN1193685
Ottone satinato
Satined brass

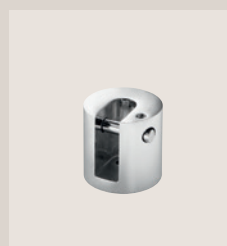

MPIN1383685
Cromo - Chrome

Lavorazioni su richiesta
Customization on demand

1500-01-028 Allungamento cavo (MAX 8 m) / Extra cable length (MAX 8 m)



ECV3755
Nero - Black



ECV3255
Trasparente - Transparent

stepdimmer



LA LUCE GIUSTA, IN OGNI MOMENTO.

Lo stepdimmer è un sistema di regolazione della luminosità che consente di selezionare tre livelli di luce preimpostati – 100%, 40% e 10% – semplicemente tramite il normale interruttore. È sufficiente scegliere l'intensità desiderata, premendo l'interruttore più volte in modo ravvicinato per scorrere i diversi livelli, e mantenerla per circa 15 secondi: il sistema memorizza automaticamente il livello selezionato. Alla successiva accensione, l'apparecchio riprenderà l'intensità precedentemente impostata, senza necessità di dimmer esterni. Una tecnologia intelligente che unisce comfort e semplicità d'uso, permettendo di creare l'atmosfera perfetta in ogni ambiente. Massima libertà di gestione della luce, senza installazioni aggiuntive e senza modifiche all'impianto.

THE RIGHT LIGHT, AT ANY MOMENT.

Stepdimmer is a light regulation system that allows you to select three preset brightness levels – 100%, 40% and 10% – simply using the standard wall switch.

Just choose the desired intensity by pressing the switch repeatedly in quick succession to cycle through the different levels, then leave it on for approximately 15 seconds: the system will automatically memorize the selected setting. When switched on again, the fixture will return to the previously selected intensity, with no need for external dimmers. An intelligent technology that combines comfort and ease of use, allowing you to create the perfect atmosphere in any space. Maximum freedom in light control, with no additional installations or modifications to the electrical system required.



Driver su richiesta
Driver on demand

PHASE-CUT DIMMER

Driver dimmerabile a taglio di fase disponibile come accessorio su richiesta, da sostituire al driver STEPDIMMER fornito di serie con i rosni.

Phase-cut dimmable driver available as an accessory upon request, to replace the standard STEPDIMMER driver supplied with the frames.

EATKL38T1
3804-40 / 3804-41 / 3804-45

EATKL38T3
3804-49 / 3806-45

EATKL38T5
3804-46 / 3805-47 / 3805-48
3809-42 / 3809-43

EATKL38T2
3804-42 / 3804-47 / 3806-42

EATKL38T4
3804-44 / 3804-48 / 3806-44

EATKL38T6
3805-40 / 3805-41

Overview

glass lampshade & W

<p>H 150 Ø 160</p>	<p>3848-51-125 ■ Ambra Amber</p>	<p>3848-51-189 ■ Oro Gold</p>	<p>3848-51-241 □ Trasparente Transparent</p>	<p>3848-51-379 ■ Grigio chiaro sfumato Shaded light grey</p>	<p>3848-51-382 ■ Marrone chiaro Light brown</p>
<p>page 73</p>					
<p>H 220 Ø 230</p>	<p>3848-52-125 ■ Ambra Amber</p>	<p>3848-52-189 ■ Oro Gold</p>	<p>3848-52-241 □ Trasparente Transparent</p>	<p>3848-52-379 ■ Grigio chiaro sfumato Shaded light grey</p>	<p>3848-52-382 ■ Marrone chiaro Light brown</p>
<p>page 73</p>					
<p>H 120 Ø 200</p>	<p>3849-51-125 ■ Ambra Amber</p>	<p>3849-51-241 □ Trasparente Transparent</p>	<p>3849-51-382 ■ Marrone chiaro Light brown</p>	<p>3849-51-388 ■ Bronzo sfumato Shaded bronze</p>	
<p>page 79</p>					
<p>H 200 Ø 130</p>	<p>3824-54-332 ■ Oro sfumato Shaded gold</p>	<p>3824-54-378 ■ Cognac sfumato Shaded cognac</p>	<p>3824-54-379 ■ Grigio chiaro sfumato Shaded light grey</p>		
<p>page 85</p>					
<p>H 150 Ø 150</p>	<p>3824-52-332 ■ Oro sfumato Shaded gold</p>	<p>3824-52-378 ■ Cognac sfumato Shaded cognac</p>	<p>3824-52-379 ■ Grigio chiaro sfumato Shaded light grey</p>		
<p>page 91</p>					
<p>H 110 Ø 180</p>	<p>3824-50-332 ■ Oro sfumato Shaded gold</p>	<p>3824-50-378 ■ Cognac sfumato Shaded cognac</p>	<p>3824-50-379 ■ Grigio chiaro sfumato Shaded light grey</p>		
<p>page 97</p>					
<p>H 143 Ø 150</p>	<p>3804-51-369 ■ Trasparente/cuore Transparent/heart</p>	<p>3804-51-370 ■ Trasparente/farfalla Transparent/ butterfly</p>	<p>3804-51-371 ■ Trasparente/pesce Transparent/fish</p>	<p>3804-51-372 ■ Trasparente/goccia Transparent/drop</p>	<p>3804-53-102 ■ Bianco White</p>
<p>page 110 - 111</p>					
<p>H 126 Ø 150</p>					<p>page 117</p>

H 142
Ø 150
page 103

	3804-54-126 ■ Fumé Transparent grey	3804-54-189 ■ Oro Gold	3804-54-241 □ Trasparente Transparent	3804-54-365 □ Cognac

H 193
Ø 200
page 103

	3804-55-126 ■ Fumé Transparent grey	3804-55-189 ■ Oro Gold	3804-55-241 □ Trasparente Transparent	3804-55-365 □ Cognac

H 130
Ø 250
page 121

	3823-50-378 □ Cognac sfumato Shaded cognac	3823-50-379 ■ Grigio chiaro sfumato Shaded light grey		3823-51-365 □ Cognac	3823-51-377 ■ Grigio chiaro trasp. Transparent light grey

H 165
Ø 180
page 125

H 90
Ø 160
page 129

	3804-59-126 ■ Fumé Transparent grey	3804-59-365 □ Cognac		3804-52-241 □ Trasparente Transparent	3804-52-365 □ Cognac

H 100
Ø 180
page 135

H 205
Ø 190
page 139

	3823-52-107 ■ Ametista Amethyst	3823-52-365 □ Cognac	3823-52-377 ■ Grigio chiaro trasparente Transparent light grey

H 215
Ø 160
page 143

	3823-54-107 ■ Ametista Amethyst	3823-54-365 □ Cognac	3823-54-377 ■ Grigio chiaro trasparente Transparent light grey

H 195
Ø 200
page 147

	3823-53-107 ■ Ametista Amethyst	3823-53-365 □ Cognac	3823-53-377 ■ Grigio chiaro trasparente Transparent light grey

Overview

metal shade & W

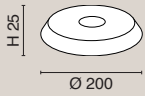

page 159

Esterno
External

Interno
Internal



3804-56-101

■ Nero
Black



3804-56-102

□ Bianco
White

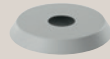

3804-56-288

■ Grigio
Grey



3804-56-355

■ Sabbia
Sand

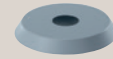

3804-56-374

■ Blu avio
Aviation blue

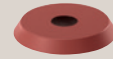

3804-56-375

■ Rosso mattone
Brick red

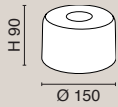

page 155

Esterno
External

Interno
Internal



3804-57-101

■ Nero
Black



3804-57-102

□ Bianco
White



3804-57-288

■ Grigio
Grey



3804-57-355

□ Bianco
White



3804-57-374

■ Blu avio
Aviation blue



3804-57-375

■ Rosso mattone
Brick red

□ Bianco
White

□ Bianco
White

□ Bianco
White

□ Bianco
White

□ Bianco
White

□ Bianco
White

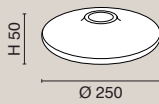

page 151

Esterno
External

Interno
Internal



3804-58-101

■ Nero
Black



3804-58-102

□ Bianco
White



3804-58-288

■ Grigio
Grey



3804-58-355

□ Bianco
White

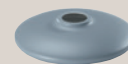

3804-58-374

■ Blu avio
Aviation blue



3804-58-375

■ Rosso mattone
Brick red

□ Bianco
White

□ Bianco
White

□ Bianco
White

□ Bianco
White

□ Bianco
White

□ Bianco
White



Overview

glass lampshade 14W

H 270 Ø 280 page 73						
		3848-53-125 ■ Ambra Amber	3848-53-189 ■ Oro Gold	3848-53-241 □ Trasparente Transparent	3848-53-379 ■ Grigio chiaro sfumato Shaded light grey	3848-53-382 ■ Marrone chiaro Light brown
H 170 Ø 280 page 79						
		3849-52-125 ■ Ambra Amber	3849-52-241 □ Trasparente Transparent	3849-52-382 ■ Marrone chiaro Light brown	3849-52-388 ■ Bronzo sfumato Shaded bronze	
H 280 Ø 200 page 85						
		3824-55-332 ■ Oro sfumato Shaded gold	3824-55-378 ■ Cognac sfumato Shaded cognac	3824-55-379 ■ Grigio chiaro sfumato Shaded light grey		
H 240 Ø 240 page 91						
		3824-53-332 ■ Oro sfumato Shaded gold	3824-53-378 ■ Cognac sfumato Shaded cognac	3824-53-379 ■ Grigio chiaro sfumato Shaded light grey		
H 175 Ø 280 page 97						
		3824-51-332 ■ Oro sfumato Shaded gold	3824-51-378 ■ Cognac sfumato Shaded cognac	3824-51-379 ■ Grigio chiaro sfumato Shaded light grey		
H 240 Ø 250 page 103						
		3805-55-126 ■ Fumé Transparent grey	3805-55-189 ■ Oro Gold	3805-55-241 □ Trasparente Transparent	3805-55-365 ■ Cognac	
H 195 Ø 330 page 135						
		3805-52-241 □ Trasparente Transparent	3805-52-365 ■ Cognac			
H 240 Ø 250 page 110						
		3805-51-372 □ Trasparente/goccia Transparent/drop				
H 214 Ø 250 page 117						
		3805-53-102 □ Bianco White				

Overview

metal shade 14W

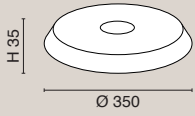

page 159	3805-56-101	3805-56-102	3805-56-288	3805-56-355	3805-56-374	3805-56-375
Esterno External	■ Nero Black	□ Bianco White	■ Grigio Grey	■ Sabbia Sand	■ Blu avio Aviation blue	■ Rosso mattone Brick red
Interno Internal	■ Nero Black	□ Bianco White	■ Grigio Grey	■ Sabbia Sand	■ Blu avio Aviation blue	■ Rosso mattone Brick red

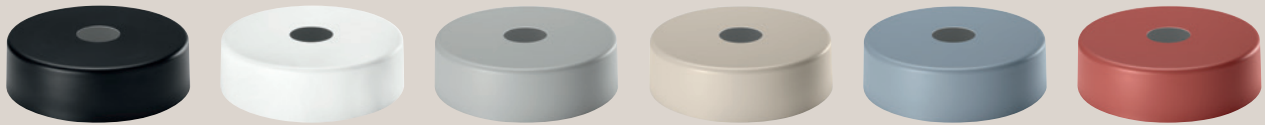
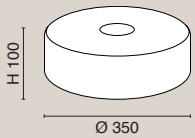

page 155	3805-57-101	3805-57-102	3805-57-288	3805-57-355	3805-57-374	3805-57-375
Esterno External	■ Nero Black	□ Bianco White	■ Grigio Grey	■ Sabbia Sand	■ Blu avio Aviation blue	■ Rosso mattone Brick red
Interno Internal	□ Bianco White	□ Bianco White	□ Bianco White	□ Bianco White	□ Bianco White	□ Bianco White

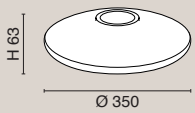

page 151	3805-58-101	3805-58-102	3805-58-288	3805-58-355	3805-58-374	3805-58-375
Esterno External	■ Nero Black	□ Bianco White	■ Grigio Grey	■ Sabbia Sand	■ Blu avio Aviation blue	■ Rosso mattone Brick red
Interno Internal	□ Bianco White	□ Bianco White	□ Bianco White	□ Bianco White	□ Bianco White	□ Bianco White

Overview

frames & W

Ø 70



Single Recessed

3804-40-101 page 160
 ■ Nero - Black
3804-40-102
 □ Bianco - White

Ø 130



Single Round

3804-41-101 page 160
 ■ Nero - Black
3804-41-102
 □ Bianco - White

Ø 350



3 Lights Round

3804-47-101 page 161
 ■ Nero - Black
3804-47-102
 □ Bianco - White

Ø 500



5 Lights Round

3804-49-101 page 161
 ■ Nero - Black
3804-49-102
 □ Bianco - White

Ø 180



2 Lights Radial

3804-42-101 page 162
 ■ Nero - Black
3804-42-102
 □ Bianco - White

Ø 200



4 Lights Radial

3804-44-101 page 162
 ■ Nero - Black
3804-44-102
 □ Bianco - White

L 870



4 Lights Rectangular

3804-48-101 page 163
 ■ Nero - Black
3804-48-102
 □ Bianco - White

L 1000



6 Lights Rectangular

3804-46-101 page 163
 ■ Nero - Black
3804-46-102
 □ Bianco - White

Ø 90



Single Round
Raise & Fall

3804-45-101 page 164
 ■ Nero - Black
3804-45-102
 □ Bianco - White

Ø 350



3 Lights Round
Raise & Fall

3806-42-101 page 164
 ■ Nero - Black
3806-42-102
 □ Bianco - White

L 1050



4 Lights Rectangular
Raise & Fall

3806-44-101 page 165
 ■ Nero - Black
3806-44-102
 □ Bianco - White

L 1400

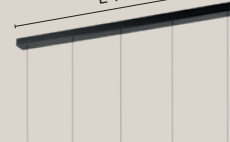

5 Lights Rectangular
Raise & Fall

3806-45-101 page 165
 ■ Nero - Black
3806-45-102
 □ Bianco - White

L 185



Track 48V

6525-56-011 On/Off page 166
6525-56-014 DALI
6525-56-016 Dimmer Push
 ■ Nero - Black

6525-55-011 On/Off page 166
6525-55-014 DALI
6525-55-016 Dimmer Push
 □ Bianco - White

Ø 120



Base Round

3823-90-101 page 167
 ■ Nero - Black
3823-90-102
 □ Bianco - White

3823-90-115
 ■ Cannafucile - Gun Metal
3823-90-119
 ■ Ottone Satinato - Satined brass

Ø 120



Base Round

3823-91-101 page 167
 ■ Nero - Black
3823-91-102
 □ Bianco - White

3823-91-115
 ■ Cannafucile - Gun Metal
3823-91-119
 ■ Ottone Satinato - Satined brass

Overview

frames 14W

Ø 130



Single Round

3805-41-101 page 168

■ Nero - Black

3805-41-102

□ Bianco - White

Ø 500



3 Lights Round

3805-47-101 page 168

■ Nero - Black

3805-47-102

□ Bianco - White

L 1150

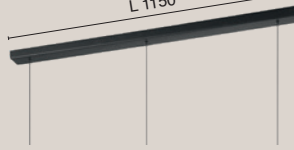

3 Lights Rectangular

3805-48-101 page 169

■ Nero - Black

3805-48-102

□ Bianco - White

Ø 90



Single Round Raise & Fall

3805-40-101 page 170

■ Nero - Black

3805-40-102

□ Bianco - White

Ø 450



3 Lights Round Raise & Fall

3809-42-101 page 170

■ Nero - Black

3809-42-102

□ Bianco - White

L 1150

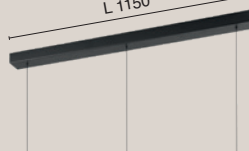

3 Lights Rectangular Raise & Fall

3809-43-101 page 171

■ Nero - Black

3809-43-102

□ Bianco - White

L 185



Track 48V

6525-56-012 On/Off page 172

6525-56-015 DALI

6525-56-017 Dimmer Push

■ Nero - Black

6525-55-012 On/Off page 172

6525-55-015 DALI

6525-55-017 Dimmer Push

□ Bianco - White

Ø 180

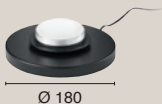

Base Round

3823-92-101 page 173

■ Nero - Black

3823-92-102

□ Bianco - White

3823-92-115

■ Canna fucile - Gun Metal

3823-92-119

■ Ottone satinato - Satined brass

accessories

Ø 30



Cable support

MPIN1013685 page 174

■ Nero - Black

MPIN1023685

□ Bianco - White

MPIN1383685

■ Cromo - Chrome

MPIN1193685

■ Ottone satinato - Satined brass

Visual merchandising Display proposals

Sono disponibili pannelli riepilogativi con soluzioni espositive, ideali per esporre e raccontare il sistema Kit Luci in modo chiaro ed efficace. Si tratta di un supporto concreto per accompagnare rivenditori e progettisti nella presentazione del prodotto.

EDISON

5 mm FOREX RIGID PANEL - 600 x 1000 mm



In caso di richiesta combinata, i due pannelli devono essere posizionati affiancati, per garantire continuità visiva e coerenza espositiva.

In the case of a combined request, the two panels must be placed side by side to ensure visual continuity and display consistency.

IT CPAN-26-03-IT
EN CPAN-26-03-EN
DE CPAN-26-03-DE
FR CPAN-26-03-FR

IT CPAN-26-04-IT
EN CPAN-26-04-EN
DE CPAN-26-04-DE
FR CPAN-26-04-FR



Summary panels with display solutions, ideal for showcasing and explaining the Kit Luci system clearly and effectively. They provide practical support for retailers and designers in presenting the product.

LED

5 mm FOREX RIGID PANEL - 600 x 1000 mm



In caso di richiesta combinata, i due pannelli devono essere posizionati affiancati, per garantire continuità visiva e coerenza espositiva.

In the case of a combined request, the two panels must be placed side by side to ensure visual continuity and display consistency.

IT CPAN-26-01-IT
 EN CPAN-26-01-EN
 DE CPAN-26-01-DE
 FR CPAN-26-01-FR

IT CPAN-26-02-IT
 EN CPAN-26-02-EN
 DE CPAN-26-02-DE
 FR CPAN-26-02-FR



condizioni generali di vendita

1. Premessa

1.1) Le presenti condizioni generali di vendita costituiscono parte integrante di tutti i contratti di vendita conclusi tra l'Acquirente (indicato in calce) ed il Venditore, FABAS LUCE S.p.A., con sede in Via Luigi Talamoni 75 - 20861 - Brugherio (MB) Italia, Tel. +39039890691 Fax +39039214208, mail info@fabasluce.it, P.IVA e cod.fisc. IT 10725990153 (di seguito indicata come FABAS), qualsiasi sia la forma con la quale gli stessi ordini vengono stipulati (e-mail, PEC, fax, raccomandata).

2. Accettazione

2.1) L'ordine deve essere effettuato dall'Acquirente con uno dei mezzi di cui all'articolo 1.1.
2.2) Gli ordini si considerano accettati e la vendita perfezionata al momento in cui FABAS invia all'Acquirente la conferma scritta dei termini e condizioni specifiche di vendita.
2.3) Ai sensi dei termini della vendita sono da considerare come integrate anche le condizioni di vendita riportate nella relativa fattura emessa da FABAS.
2.4) È espressamente esclusa l'applicabilità di eventuali condizioni generali di vendita dell'Acquirente e/o di qualunque altro documento equipollente che dovesse essere emesso da quest'ultimo.
2.5) Le presenti condizioni generali hanno durata a tempo indeterminato, salvo specifico recesso di una parte da comunicarsi per iscritto con preavviso non inferiore a 6 (sei) mesi. La comunicazione di recesso non pregiudica le lavorazioni e/o gli ordini in corso o per le quali siano già stati perfezionati gli ordini, con obbligo in capo all'Acquirente alla corresponsione integrale dei corrispettivi per queste pattuiti.

3. Luogo e modalità di resa

3.1) Le forniture devono essere consegnate secondo i termini di resa INCOTERMS 2025 specificati nella offerta di FABAS e/o nella conferma d'ordine.
3.2) È onere dell'Acquirente mettere tempestivamente a disposizione del Venditore tutte le informazioni ed i dati necessari per dare esecuzione alla fornitura; eventuali ritardi da parte dell'Acquirente comporteranno automaticamente una corrispondente proroga dei termini di consegna.

4. Termini di consegna

4.1) I termini temporali di consegna riportati nell'ordine o nella fattura sono da intendersi a titolo indicativo e non perentorio; pertanto, il ritardo "non rilevante" nell'evasione dell'ordine da parte di FABAS non potrà costituire motivo di annullamento dell'ordine stesso da parte dell'Acquirente e non darà diritto a quest'ultimo di richiedere a FABAS alcun risarcimento e/o indennizzo di sorta.
4.2) Si considera non rilevante un ritardo nell'evasione dell'ordine non superiore a n. 30 giorni lavorativi.
4.3) Nel caso si verificano cause di forza maggiore, si applicheranno le norme di cui all'art. 1218 del Codice Civile (Codice Civile - R.D. n. 262/1942) e ss cc, fermo restando che FABAS si adopera al meglio delle sue possibilità per limitare gli effetti negativi conseguenti dalla intervenuta impossibilità della prestazione.
4.4) Sono da considerarsi "cause di forza maggiore" a titolo esemplificativo, ma non esaustivo, i seguenti eventi: fenomeni eccezionali ed avversi (sisma, alluvione, maremoto, incendio, alluvione, frana, altre calamità naturali), altri eventi esterni imprevedibili (scioperi selvaggi dei mezzi di trasporto, serrate sindacali, guerre, atti di terrorismo, provvedimenti dell'autorità amministrativa e/o giudiziaria, furti di materie prime o prodotti finiti), shortage di materiali, ritardi e/o problematiche connesse ai trasporti.
4.5) Il contratto di vendita si intenderà risolto di diritto nel caso in cui l'Acquirente non provveda al ritiro della merce presso il luogo di consegna pattuito entro 15 giorni successivi alla data concordata per la consegna, con pieno diritto per FABAS di richiedere il risarcimento dei danni e delle spese.

5. Qualità della merce

5.1) FABAS garantisce che la merce consegnata è conforme alle caratteristiche prescelte dall'Acquirente; a quelle indicate nelle proprie schede tecniche e cataloghi, agli standard eventualmente prescritti dalla Legge Italiana e dell'Unione Europea attualmente vigenti, anche in materia di sicurezza.
5.2) La merce fornita da FABAS è esente da vizi o difetti che la rendano inidonea all'uso per cui è stata fabbricata ed a cui è normalmente destinata (uso indicato nel sito, nel catalogo e nelle schede tecniche), a meno che l'Acquirente non abbia espressamente ordinato merce con particolari caratteristiche extra-catalogo, non richiamate dalle schede tecniche. In tale ultima ipotesi FABAS non si assume alcuna responsabilità per quanto possa verificarsi in conseguenza dell'utilizzo di prodotti modificati su esplicita richiesta dell'Acquirente.
5.3) FABAS non effettua vendite su campione o su tipo campione. I campioni eventualmente forniti da FABAS o richiesti dall'Acquirente non comportano per FABAS le garanzie qualitative ritualmente previste dalla Legge per prodotti venduti sul mercato e gli obblighi indicati al seguente art. 6.
5.4) La merce viene venduta e consegnata in imballaggi conformi alla Legge.
5.5) FABAS non assume alcuna responsabilità sul mantenimento delle caratteristiche qualitative del prodotto fornito qualora lo stesso, dopo la consegna, sia stato manipolato e/o trasformato dall'Acquirente senza che quest'ultimo abbia preventivamente consultato FABAS e richiesto la sua autorizzazione ad intervenire. In assenza di esplicita autorizzazione di FABAS, in caso di intervento dell'Acquirente, quest'ultimo perderà ogni diritto alla garanzia.

6. Reclami e diritti dell'Acquirente

6.1) Nel caso in cui si verificasse un vizio o difformità qualitativa tra il prodotto consegnato e quello preventivamente ordinato, l'Acquirente dovrà darne immediata comunicazione a FABAS denunciando ai sensi della normativa vigente in forma scritta, entro 8 giorni di calendario dal ricevimento della merce o dalla scoperta del fatto (per mezzo di e-mail o fax al n +390392142208, o e-mail all'indirizzo info@fabasluce.it) i vizi di non conformità rispetto alle caratteristiche tecniche indicate da FABAS. La garanzia è fornita per un periodo di 24 (ventiquattro) mesi decorrenti dalla data di spedizione dei prodotti, fatto salvo il caso che nel catalogo prodotti di FABAS non siano indicati termini di validità di garanzia differenti. In caso di reclamo, l'Acquirente dovrà in ogni caso astenersi dall'utilizzare il prodotto contestato, che dovrà essere idoneamente conservato onde consentire a FABAS di poter eseguire tutti i controlli e analisi opportune sulla merce contestata. Ogni denuncia da parte dell'Acquirente di vizi, difetti o difformità dovrà essere accompagnata e provata, a pena di inefficacia, da documentazione fotografica o da equipollente modalità riproduttiva, che ne certifichi la sussistenza.
6.2) In caso di fondatezza del reclamo FABAS provvederà, in primo luogo, a riparare a proprie spese il prodotto risultato non conforme o difettoso ovvero, a rifonderne il prezzo,

ma solamente qualora non fosse in grado preliminarmente di ripararlo. Resta in ogni caso inteso che la garanzia comprende esclusivamente la fornitura del materiale per le riparazioni da parte di FABAS; ogni attività ulteriore (ivi compresi gli interventi e l'installazione in loco) sarà pertanto ad esclusivo carico e spesa dell'Acquirente.

6.3) Nei casi di cui agli artt. 6.1, 6.2 nessuna richiesta di risarcimento per danni diretti e/o indiretti potrà essere avanzata dall'Acquirente nei confronti di FABAS, anche in caso di fondatezza del reclamo.

6.4) L'insorgere di un reclamo non darà diritto all'Acquirente di risolvere immediatamente ed unilateralmente il contratto, né di sospendere od omettere in tutto e/o in parte il pagamento del prodotto.

6.5) Il presente articolo 6 stabilisce gli unici obblighi di garanzia del Venditore, e i rimedi esclusivi dell'Acquirente per reclami basati su difetti relativi ai prodotti forniti.

7. Prezzi e pagamenti

7.1) I prezzi di vendita dei prodotti FABAS sono quelli risultanti dalle fatture pro-forma o dalle fatture definitive di acquisto.

7.2) Le modalità ed i termini di pagamento sono quelli pattuiti e riportati nella fattura definitiva, o nella pro-forma, o nei DDT emessi da FABAS.

7.3) Sarà facoltà del Venditore modificare i corrispettivi pattuiti, anche in corso di esecuzione, in caso di aumento dei costi delle materie prime superiore al 10%. In tutti i predetti casi il Venditore provvederà a darne notizia all'Acquirente, indicando le ragioni e l'adeguamento del corrispettivo, osservato un congruo preavviso.

8. Mancato o ritardato pagamento

8.1) In caso di mancato o ritardato pagamento anche parziale, rispetto alla scadenza pattuita ed indicata in fattura verranno applicate le norme di cui al D.Lgs. 09.10.2002 n.231, ivi comprese quelle attinenti alla decorrenza degli interessi ed il saggio degli stessi.

8.2) Eventuali ritardi o inadempimenti nel pagamento del corrispettivo, anche per una sola fattura, legittimeranno il Venditore a sospendere ogni attività. Dal momento in cui il corrispettivo precedentemente non pagato nei termini concordati giunga nella disponibilità del Venditore, questi riprenderà le attività di produzione/fornitura in un tempo ragionevolmente compatibile con il proprio ciclo produttivo. Il periodo di tempo in cui le forniture sono state oggetto di sospensione sarà automaticamente aggiunto ai termini di consegna concordati, o a quelli normalmente attesi in relazione alle lavorazioni concordate.

9. Responsabilità di FABAS

9.1) In nessun caso FABAS sarà responsabile per danni indiretti, perdite di profitti/affari/opportunità o perdita di avviamento.

10. Trasferimento di rischio e proprietà

10.1) Il rischio di perdita o danneggiamento della merce fornita sarà trasferito in capo all'Acquirente alla consegna dei termini di resa Incoterms 2025 pattuiti.

10.2) La proprietà della fornitura sarà trasferita all'Acquirente successivamente al pagamento integrale da parte di quest'ultimo del corrispettivo pattuito.

11. Proprietà intellettuale, riservatezza e privacy

11.1) Ciascuna parte si obbliga a mantenere a tutta la propria totale riservatezza riguardo ad ogni informazione, dato (anche tecnico), documento, processo di produzione, progetto, know-how, disegno, software, strategia commerciale, prezzo, cliente e più in generale attività dell'altra parte (le "Informazioni Riservate"), dei quali sia venuta o verrà a conoscenza in fase di trattativa precontrattuale o durante l'esecuzione del presente rapporto contrattuale.

11.2) Le parti potranno utilizzare le Informazioni Riservate al solo ed unico fine di correttamente adempiere alle obbligazioni previste dal presente rapporto contrattuale. In particolare, ed a titolo esemplificativo, le parti non potranno diffondere né comunicare a terzi le Informazioni Riservate, a meno che non sia previsto da disposizioni di legge, regolamentari e/o da richieste di autorità pubbliche e/o giudiziarie.

11.3) Le parti si impegnano ad ogni modo a far osservare i medesimi obblighi di riservatezza ai dipendenti/collaboratori/funzionari propri che siano venuti o verranno a conoscenza delle Informazioni Riservate, garantendone l'adempimento anche quale promessa del fatto di terzo ai sensi dell'articolo 1381 cod. civ.

11.4) Ciascuna parte si obbliga, a semplice richiesta dell'altra Parte, a riconsegnare tutti i documenti o altro materiale contenente le Informazioni Riservate, in qualsiasi forma posseduti, ovvero a distruggere e certificare la distruzione di detto materiale, nonché a cancellare o distruggere qualsiasi copia o registrazione delle Informazioni Riservate effettuata su computer o attraverso qualsiasi altro strumento e supporto informatico.

11.5) I diritti di privativa industriale e/o intellettuale, compreso il relativo know-how, nonché ogni risultato suscettibile di formare oggetto di diritti di privativa, elaborati, forniti, inglobati/ricompresi nella merce, o comunque comunicati da FABAS all'Acquirente, sono e restano di esclusiva proprietà di FABAS.

11.6) Le Parti si danno atto di essersi reciprocamente informate ed autorizzate al trattamento dei dati personali, ai sensi del D. Lgs. n. 196/2003 (e s.m.i.) e del Regolamento UE 679/2016 (e s.m.i.), dichiarandosi all'uopo edotte dei diritti conferiti dalle predette disposizioni di legge, in relazione agli adempimenti connessi all'esecuzione del presente rapporto contrattuale..

12. Legge applicabile e Foro competente

12.1) Le presenti condizioni generali ed i singoli rapporti di fornitura sono disciplinati dalla legge italiana. È esclusa l'applicazione della "Convenzione di Vienna del 1980 sulla vendita internazionale di merci" e di altre convenzioni, regolamenti o norme di diritto internazionale relative alla vendita di merci e/o alla fornitura (anche di servizi).

12.2) Per tutte le controversie derivanti dall'interpretazione, o dall'esecuzione del presente rapporto contrattuale viene pattuita la competenza esclusiva del Foro di Monza (Italia).

ATTENZIONE:

I prodotti FABAS sono registrati e protetti da brevetto; le contraffazioni saranno perseguibili giuridicamente.

Ci riserviamo il diritto di proprietà su questo catalogo.

I disegni, i materiali e i colori dei prodotti riportati nei cataloghi, sul sito internet e, più in generale, in tutto il materiale pubblicitario, sono da intendersi a titolo puramente indicativo. Il Venditore si riserva il diritto di modificare, senza alcun preavviso, le caratteristiche dei propri prodotti.

I dati tecnici, le immagini e le informazioni relative ai prodotti non sono vincolanti per il Venditore, il quale non risponde di eventuali difformità e/o errori illustrativi e/o testuali.

general sales conditions

1. Premise

1.1) The following general sales conditions are essential part of all sale contracts concluded between the Purchaser and the Seller, FABAS LUCE S.p.A., located in Via Luigi Talamoni 75 - 20861 - Brugherio (MB) Italy - Pho. +39039890691 Fax +390392142208, mail: info@fabasluceluce.it, VAT N. IT10725990153 (hereinafter referred to as FABAS), no matter which procedure the sale orders are stipulated between the Parties (e-mail, registered e-mail, fax, registered letter).

2. Acceptance

2.1) Orders must be placed by the Purchaser through one of the procedures listed in 1.1.
2.2) Orders will be deemed accepted and the sale executed when FABAS will send the written confirmation for the specific order to the customer.
2.3) The Parties agree to integrate the terms of sale also with the conditions issued by FABAS on any sale invoice.
2.4) Applicability of any general conditions of sale of the Purchaser and / or any other equivalent document that may be issued by the latter is expressly excluded.
2.5) These general conditions have an indefinite duration; each party is in any case entitled to freely withdraw from these general conditions by means of written notice to be sent at least 6 (six) months in advance. Such withdrawal does not affect all work and/or in progress or for which orders have already been completed, with the Purchaser being obliged to pay in full the consideration agreed upon.

3. Delivery place and terms

3.1) The goods must be delivered according to the INCOTERMS 2025 specified in the offer sent by FABAS and/or in the order confirmation.
3.2) It is the Purchaser's responsibility to promptly make available to the Seller all the information and data necessary to execute the supply; any delays on the part of the Purchaser will automatically result in a corresponding extension of the delivery terms

4. Delivery

4.1) Delivery time agreed for the products on the sale orders and issued on the final invoices must be considered as a reference but not as a rigid indication; therefore a "not relevant" delay on the delivery of the ordered products, made by FABAS, must not be considered by the Purchaser as a breach of the contract. Therefore in this last case the Purchaser will not have any right to claim any compensation and/or indemnity to FABAS.
4.2) On the basis of the present terms of sale it is deemed "not relevant" a delay not exceeding n. 30 working days.
4.3) Where force majeure events occur, the rules of Article 1218 of the Italian Civil Code (Codice Civile – R.D. n. 262/1942) must be applied, nonetheless DGA will make all efforts to limit the negative effects resulting from the supervening impossibility of performance.
4.4) The following events are deemed "force majeure events" as an example (but not as an exhaustive list): adverse and exceptional phenomena (earthquake, flood, tsunami, fire, flood, landslide and other natural disasters), other unforeseeable external events (wildcat strikes of transport services, strikes or lockouts, war, act of terrorism, provisions of administrative and judicial authorities, theft of raw materials or finished products, exaggerated increases in the prices of raw materials), shortage of materials, delays and / or problems related to transport.
4.5) Any sale agreement shall be deemed terminated in the event that the Purchaser fails to pick up the goods at the agreed place of delivery within 15 days after the agreed delivery date. In this case FABAS is entitled to claim compensation for damages and costs.

5. Goods quality

5.1) FABAS ensures that the delivered products fully comply with the features selected by the Purchaser; with the characteristics indicated in the technical data sheets and catalogues and with the standards prescribed by Italian and European Union Laws currently in force, including all the mandatory safety regulations.
5.2) The goods supplied by FABAS are free from defects that make such goods unfit or unable for the use for which they were manufactured or which is normally intended to (uses indicated on the website, in the catalogues and in the technical data sheets), unless the Purchaser has expressly ordered goods with special features, not included in the sale catalogues or not mentioned by the technical specifications. In this last case FABAS does not assume any liability for what may occur as a result of the modifications required on the products by the Purchaser.
5.3) FABAS does not process sales of samples. Samples provided by FABAS or requested by the Purchaser shall not oblige FABAS to provide the same standard quality warranty prescribed by the Law and by the following art. 6 for products regularly sold on the market.
5.4) The goods are packaged in accordance with the applicable laws.
5.5) FABAS does not assume any responsibility for the maintenance of products quality, in case the same products after the delivery have been modified and/or transformed by the Purchaser without the latter's prior consultation and authorization of FABAS. In absence of explicit authorization of FABAS, the Purchaser will lose all warranty rights.

6) Complaints and rights of the Purchaser

6.1) In case of defects of the delivered products, the Purchaser shall immediately send a prior and written notice of complaint to FABAS, in accordance with the Laws, within 8 days after the receipt of the goods or the acknowledgement of the defect (through registered letter, fax to +390392142208, or e-mail at info@fabasluceluce.it) mentioning any single element of non-compliance with the technical specifications of FABAS catalogues. Warranty is provided for a period of 24 (twentyfour) months starting from the shipment date, unless different guarantee terms are indicated in the FABAS product catalogue. In the event of a complaint, the Purchaser shall in any case refrain from using the disputed product, which must be properly stored in order to allow FABAS to be able to perform all appropriate checks and analyses on the disputed goods. Any complaint by the Purchaser of flaws, defects or discrepancies must be accompanied and proven, under penalty of ineffectiveness, by photographic documentation or an equivalent reproductive method, which certifies their existence.
6.2) In case of confirmed defects, FABAS will first repair at its own expenses the defective item and then, in case the repair is not possible, will refund the cost of the purchase. In any case, it is understood that the guarantee only includes the supply by FABAS of materials necessary for the repair works; any further activity (including interventions and on-site installation) will therefore be the sole responsibility and expense of the Buyer.
6.3) No compensation claim for any direct and/or indirect damage may be made by the Purchaser against FABAS, in case FABAS' conduct complies with the above mentioned art. 6.1, 6.2.

6.4) In case of complaint, the Purchaser does not have the right to terminate the contract immediately and unilaterally, nor to suspend or to avoid to process the payment for the purchased products, totally or partially.

6.5) This article 6 establishes Seller's only warranty obligations, and Purchaser's exclusive remedies for claims based on defects in the products supplied.

7. Prices and payments

7.1) FABAS products sale prices are specifically indicated in the pro-forma invoices and/or in the final sales invoices.
7.2) Final conditions and terms of payment are the ones agreed and issued in the final invoices, or in the pro-forma invoices, or in the Delivery Note issued by FABAS.
7.3) The Seller will be entitled to modify the agreed fees, even during execution of the contract, in the event of an increase in the cost of raw materials exceeding 10%. In all the aforementioned cases, the Seller will notify the Purchaser, indicating the reasons and the adjustment of the consideration, subject to adequate notice.

8. Failed or delayed payment

8.1) In case of failed, delayed or partial payments with respect to the agreed deadline and indicated on the invoice, the rules referred to in Legislative Decree 09.10.2002 n. 231 will be applied, including those relating to the effective date of interest and interest rates.
8.2) Any delays or non-fulfillment in payment of the consideration, even for a single invoice, will entitle the Seller to suspend all activities. As soon as the consideration previously not paid within the agreed terms reaches the Seller's availability, the Seller will resume production / supply activities in a time reasonably compatible with its production cycle. The period of time in which the supplies have been suspended will be automatically added to the agreed delivery terms, or to those normally expected in relation to the agreed processes.

9. FABAS liability

9.1) In no event will FABAS be liable for indirect damages, loss of profits / business / opportunity or loss of goodwill.

10. Transfer of risk and ownership

10.1) Risk of loss or damage to the goods supplied will be transferred to the Purchaser in accordance with the incoterms 2025 agreed upon.
10.2) Ownership of the goods will be transferred to the Purchaser after full payment of the contract price.

11. Intellectual property, confidentiality and privacy

11.1) Each party undertakes to maintain complete confidentiality regarding any information, data (including technical), document, production process, project, know-how, design, software, commercial strategy, price, customer and more generally activities of the other party (the "Confidential Information"), of which it has come or will become aware of during the pre-contractual negotiation phase or during the execution of this contractual relationship.
11.2) The parties may use the Confidential Information for the sole purpose of correctly fulfilling the obligations set out in this contractual relationship. In particular, and by way of example, the parties may not disseminate or communicate Confidential Information to third parties, unless required by law, regulations and / or requests from public and / or judicial authorities.
11.3) The parties undertake in any case to ensure compliance with the same confidentiality obligations by their employees / collaborators / officials who have come to or will become aware of the Confidential Information, guaranteeing their fulfillment also as a promise of the fact of a third party pursuant to article 1381 of the Italian Civil Code.
11.4) Each party undertakes, at the simple request of the other Party, to return all documents or other material containing the Confidential Information, in any form it possesses, or to destroy and certify the destruction of said material, as well as to cancel or destroy any copies or recording of Confidential Information carried out on a computer or through any other computer tool and support.
11.5) Industrial and / or intellectual property rights, including the related know-how, as well as any result likely to be the subject of proprietary rights, processed, supplied, incorporated / included in the goods, or in any case communicated by FABAS to the Purchaser, are and remain the exclusive property of FABAS.
11.6) The Parties acknowledge that they have mutually informed and authorized the processing of personal data, pursuant to Legislative Decree no. 196/2003 (as amended) and EU Regulation 679/2016 (as amended), and they declare themselves for this purpose to be aware of the rights conferred by the aforementioned provisions of law, in relation to the obligations related to the execution of this contractual relationship.

12. Applicable law and jurisdiction

12.1) These general conditions and the specific supply relationships are governed by Italian law. The application of the "Vienna Convention of 1980 on the International Sale of Goods" and other conventions, regulations or rules of international law relating to the sale of goods and / or the supply (also of services) is excluded.
12.2) For all disputes arising from the interpretation or execution of this contractual relationship, the parties submit to the exclusive jurisdiction of the Court of Monza (Italy).

PLEASE NOTE:

FABAS products are protected by design registrations and patents, imitations will be prosecuted.

We reserve ownership rights to this catalogue.

Drawings, materials, and colors of the products shown in the catalogs, on the website, and, more generally, in all advertising materials, are to be considered for guidance only.

The Seller reserves the right to modify the characteristics of its products at any time without prior notice.

Technical data, images and product information are not binding for the Seller, who is not responsible for any discrepancies and/or errors in illustrations and/or text.



FABAS LUCE S.p.A.
sede

Via Luigi Talamoni, 75
20861 Brugherio (MB) Italy
Tel. 0039 039 890 69 1
0039 039 214 22 06
Fax 0039 039 214 22 08
www.fabasluce.it
info@fabasluce.it
venditefabas@fabasluce.it
salesdept@fabasluce.it



FABAS LUCE GmbH

Westring, 5
D-59759 Arnsberg Germany
Tel. 0049 29 32 / 8 90 16 60
Fax 0049 29 32 / 8 90 16 62
vertrieb@fabasluce.com



© DITRE IDEAS MAKERS

graphic artwork & photo editing
Ditre.com

photo
Quasarfoto.com

printed in Italy
April 2026

È VIETATA LA RIPRODUZIONE ANCHE
PARZIALE DI QUESTO CATALOGO.
IT IS FORBIDDEN TO REPRODUCE
ANY PART OF THIS CATALOGUE.



www.fabasluc.it

